



**DIXIE
PLUMBING
SPECIALTIES**

**OVER
25,000
ITEMS IN
STOCK**

Order On Account or
With Credit Cards



1810 Lower Roswell Road
Marietta, GA 30068

VISIT OUR WEBSITE AT
www.dixieplumbingspecialties.com

FIX-A-TOILET SPRING SPECIALS

Prices Good Through July 31, 2025



UPS shipping charges are **FREE** on all orders over \$143 net invoice
** SAVE TIME AND MONEY, CALL US TODAY **



PROFESSIONAL QUALITY YOU EXPECT

ORDER TODAY: 800-327-8531

Order Desk 9am to 5pm

Email orders to info@dixieplumbingspecialties.com

**THOUSANDS OF TOP QUALITY
PLUMBING PARTS
STOCKED IN OUR NATIONAL
DISTRIBUTION CENTER!**

Works on most all brands 3" flush valves with flappers!

- * American Standard
- * Aquasource
- * Crane
- * Eljer
- * Ferguson
- * Gerber
- * Jacuzzi
- * Kohler
- * Mansfield
- * Pegasus
- * Toto
- * Western
- * and many more

UNIVERSAL 3" MIZER FLUSH III
Adjustable | CHLOROBLOCK | TP Rubber

Saves water!
Improves flush power!

Chain tube eliminates chain interference issues

Rotating the bulb to increase or decrease flush rates and removing the baffle can achieve the perfect rate

Bulb rotates to adjust flush rates

Adjustable arms to match flush valve
Wider flush range!
Easily adjustable!

Removable baffle

Part # 33-001 1-11.....8.98 ea
12+.....8.48 ea

*Fits 98.8% of New Style 3" Flush Valves

Includes toilet settings chart by model

MADE IN USA

GENUINE NO-BUST BRAIDED STAINLESS STEEL TOILET SUPPLIES
* WITH BRASS NUT *

*3/8 od x 12" Packed 10 per bag
Part #58-372.....3.68 ea

3/8 od x 16"
Part #58-373.....3.98 ea

3/8 od x 20"
Part #58-374.....3.98 ea

FREE UPS SHIPPING
Max ON ALL ORDERS
Says: THAT INCLUDE
AT LEAST 36
#33-462

SUPER SEAL ROYAL BLUE FLAPPERS!
100% SATISFACTION GUARANTEED
OR YOUR MONEY BACK!

★ THE GENUINE DIXIE® SUPER SEAL ROYAL BLUE ★
#1 MASTER PLUMBER'S CHOICE

- * These supreme tank flappers are made up of a special silicone treated formula
- * Each flapper will last for years and are for professional plumbers
- * Packaged individually in heavy duty, truck-proof boxes
- * Fits many toilets including American Standard, Eljer, Gerber, Kilgore, Kohler, Peerless, Univ. Rundle, Sears, Western and others
- * Will actually work in most conventional toilets
- * Includes special stainless steel chain and hook

MADE IN USA

Part # 33-462 1 - 23 (individually boxed).....2.98 ea
24+ (individually boxed).....2.78 ea
Case Lot of 72 (ind. boxed).....2.29 ea
Now Available in Bulk! ➡ Case Lot of 100 (bulk).....1.99 ea



SPANNER FLANGE



- * Eliminates need to replace broken cast iron or plastic ring
- * Protects from sewer, gas and water
- * Helps stop seepage from base of toilet
- * Stops rocking toilet



Part # 33-218.....1.99 ea

GENUINE NO-BUST BRAIDED STAINLESS STEEL TOILET SUPPLIES

*3/8 od x 12"

Part #58-339.....2.48 ea

3/8 od x 16"

Part #58-337.....2.98 ea

3/8 od x 20"

Part #58-340.....2.98 ea

1/2 od x 12"

Part #58-974.....3.68 ea

Packed 10 per bag

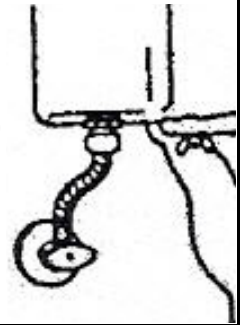

korky QUIET-FILL ANTI-SIPHON VALVE

- * Wider adjustment range 5-1/2" to 11"
- * Compact design and enclosed float
- * From-the-top servicing
- * Operates 2 to 5 times quieter than the competition
- * Anti-siphon meets all codes



Part # 33-079.....10.98 ea

LAVELLE TOTO G-MAX & POWER GRAVITY FLUSH VALVE



- * Flush valve for all Toto G-Max and Power gravity toilets
- * Higher refill percentage than other refill valves



Part # 33-032.....20.48 ea

GERBER® TANK TO BOWL KIT

Special Thick Gerber Gasket



* Packaged with 2 Tank Bolt Kits



Part # 33-1538.98 ea

ALL TANK TO BOWL KITS USE THE LARGEST DELUXE BIG HEAD SOLID BRASS TANK BOLTS 5/16" DIAMETER WITH A 1" HEAD

BIG LARGE HEAD SOLID BRASS TANK BOLTS

* Packaged in Sets of 3 Bolts



Part # 33-400.....9.48 ea

BIG LARGE HEAD SOLID BRASS TANK BOLTS

14-Piece Deluxe

* Packaged in pairs with all nuts & washers

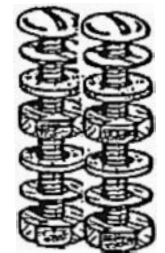

Part # 33-1457.48 pair

HEAVY DUTY WAX SEAL RING



- * Professional Grade
- * Minimum 13/16" thickness
- * Packed 1 per box and 48 per case lot

Part # 33-140
Each.....1.78 ea
Case Price.....1.58 ea

HEAVY DUTY FLANGED BOWL RING

- * Professional Grade
- * Fits both 3" and 4" soil pipe
- * Packed 1 per box and 24 per case lot



Part # 33-143
Each.....1.98 ea
Case Price.....1.78 ea

SPECIAL WALL HUNG URINAL & TOILET GASKETS

- * Extra thick
- * Urethane and wax
- * Fits 2" Urinal outlets
- * Guaranteed for 10 years
- * Will not deteriorate



Part # 33-286.....2.98 ea
 4" for Wall Hung Toilets
Part # 33-407.....2.98 ea

SOLID BRASS SNAP OFF CLOSET BOLTS

*** Bagged in Pairs ***

- * Brass bolt with captive washer, nickel plated nut, stainless washer
- * Order 12 pair per bag or 50 pair per box

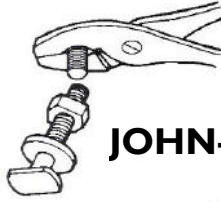

JOHN-BOLTS

1/4" x 2-1/4" Solid Brass Snap Off Closet Bolts

Part # 33-137.....2.88 pair

5/16" x 2-1/4" Solid Brass Snap Off Closet Bolts

Part # 33-138.....2.98 pair

CLOSET BOLT CAP SET

*** Bagged in Pairs ***

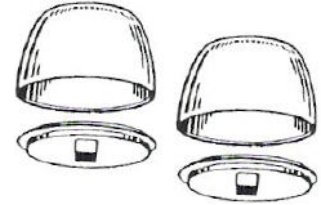

Round, white with washer

Order 12 pair per bag or 50 pair per box



Part # 33-192..... .99¢ pair

ENDURO CLOSET BOLTS

*** Bagged in Pairs ***

- * Withstands over 1,000 PSI
- * Never rusts
- * Space Age composite
- * Fits all closet flange styles
- * Order 12 pair per bag or 50 pair per box



Part # 33-061
1-49.....1.48 pair
Box of 50.....1.28 pair

AMERICAN STANDARD®

Tank to Bowl Kit

UNIVERSAL

With recess gasket

3
Bolt Kit



Part # 33-30010.98 ea

AMERICAN STANDARD®

Tank to Bowl Kit

UNIVERSAL

With recess gasket

2
Bolt Kit



Part # 33-1568.48 ea

PRO SLIP JAW PLIERS

- * Professional Quality
- * Special Cushion Grips
- * Chrome Finish
- * Drop Forged Steel
- * 2-1/8" capacity
- * 10" long



Part # 90-023.....9.77 ea

3" FLUSH VALVE W/FLAPPER HEAVY DUTY PLASTIC

- * Vinyl Flapper with a Stainless Steel Chain
- * Lugnut and Flush Valve Washer
- * Fits/Replaces Most 3" Valves on the Market

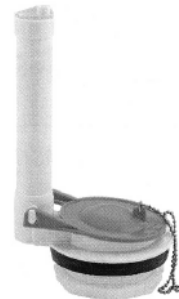

Part # 33-224
1-5.....10.88 ea
6+.....9.98 ea

*** FLUSH VALVE * 9" TALL HEAVY DUTY PLASTIC**

- * 33-462 SS Blue Flapper
- * Plastic Non-Corrosive
- * Vinyl Flapper
- * Stainless Steel Chain
- * Hex Nut
- * Includes Washer

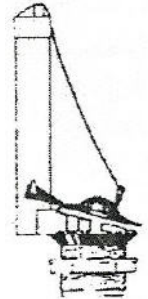

Part # 33-221
1-11.....6.98 ea
12+.....6.48 ea

GENUINE FLUIDMASTER® REPAIR KIT

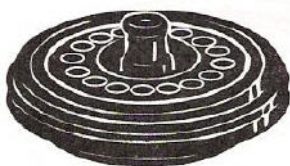

Packed 10 per zip-top bag

Part # 33-264.....1.38 ea



FLUIDMASTER® PRO 45 FILL VALVE

- * Preferred by professional plumbers
- * **Heavy-duty brass shank**
- * Ultra quiet operation
- * Minimal water hammer
- * Code approved
- * 5 year warranty
- * 1 per box or 25 per case



Brass Shank

Part # 33-595.....16.98 ea



FLUIDMASTER® PRO 45 FILL VALVE

- * Ultra quiet operation
- * Minimal water hammer
- * Code approved
- * 5 year warranty
- * 1 per box or 25 per case



Part # 33-600
1-24.....11.98 ea
Case Lot (25)...10.98 ea

for **ELJER®** and **WESTERN®**
Big 3" Titan

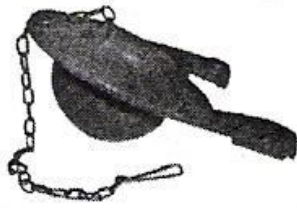

Packed 1 per box
Part # 33-882.....8.98 ea

for **TOTO®**

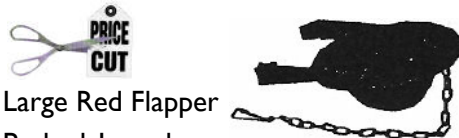

Large Red Flapper
 Packed 1 per box
Part # 33-881.....6.88 ea

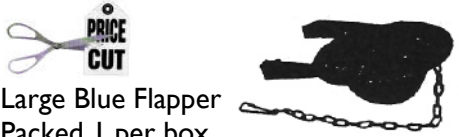

Large Blue Flapper
 Packed 1 per box
Part # 33-990.....6.98 ea

RED KORKY + FLAPPER
Genuine Korky + Red



*Blister Packed
CARTON
QUANTITIES ONLY
 12 per carton
 One-piece tank flapper
Part # 33-461.....2.98 ea



TANK TO BOWL KIT



Special Eljer Gasket



2-Bolt Kit

Part # 33-1529.48 ea



TANK TO BOWL KIT



Special Mansfield Gasket



3-Bolt Kit

Part # 33-1589.98 ea



TANK LEVERS

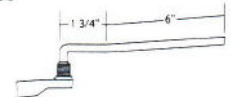

* * New Style Chrome
 for Mansfield Water-Saving Toilets
Part # 33-806.....4.98 ea



Chrome w/blue arm
Part # 33-115.....4.68 ea

Chrome w/white arm
Part # 33-805.....4.68 ea

for **ELJER®**
TOUCH FLUSH UNIT

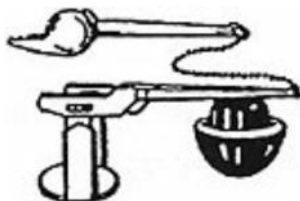

Complete with tank lever, chain, ball and arm

Packed 1 per box
Part # 33-197.....4.98 ea



211 FLUSH VALVE

- * Provides 1.6 gpf water consumption
- * Includes shank gasket and locknut
- * Accommodates all trip levers – direct or chain connection



Packed 1 per box & 10 per case
Part # 33-243.....9.98 ea



210 FLUSH VALVE

- * Provides 3.5 gpf or greater water consumption
- * Includes shank gasket and locknut
- * Accommodates all trip levers – direct or chain connection



Packed 1 per box & 10 per case
Part # 33-244.....8.98 ea

I-PIECE BALLCOCK
FOR ELJER®, AMERICAN STANDARD® & OTHERS

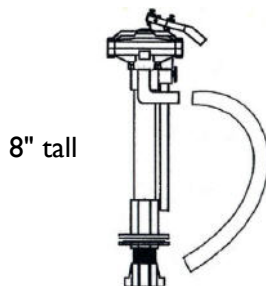

8" tall

Part # 33-00529.48



MAX

Dixie carries almost **ANY** toilet part for **ANY** brand!
Give MAX a call!



FLUSH VALVE SEAL



Old Style Large Diaphragm
Part # 33-250.....3.48 ea



New Style Small Diaphragm
Part # 33-251.....2.48 ea
 12+.....1.98 ea

**THE ORIGINAL
"EXTEND-A-FLANGE"
Closet Flange Extension**

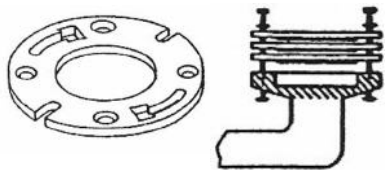

Extremely useful when repairing, replacing or tiling bathroom floor

Part # 33-320.....2.98 ea

**ADJUSTABLE 3" X 4"
CLOSET FLANGE**



- * Fits over 3" & inside 4"
- * Ideal for repair or replacement in wood or concrete
- * Allows up to 4" adjustment to riser

Part # 33-981.....15.98 ea

**4" CLOSET FLANGE
REPLACEMENT**

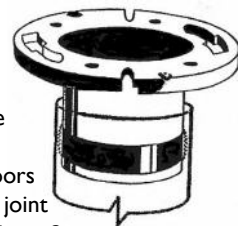

- * With up to 3" of adjustment to riser
- * No need to remove lead joint
- * No tearing up of floors
- * No caulking of lead joint
- * Slip into pipe & tighten 3 stainless steel bolts
- * Great for new concrete construction

Part # 33-982.....19.98 ea

**ANCHOR FLANGE
SPANNER KIT**



* Repairs broken closet flange *

- * Heavy Duty
- * Mounts to Floor
- * Stabilizes Toilet
- * Plated Steel Construction

Part # 33-360.....3.98 ea

**CLOSET FLANGE
REPAIR RING**



- * Securely attaches to concrete or wood sub-floor
- * Replaces most closet rings
- * Corrosion resistant

Part # 33-385.....8.48 ea

**3" STREET
ADJUSTABLE CLOSET
FLANGE**



- * Fits inside 3"
- * Eliminates the need for chipping and chiseling of concrete.
- * Allows up to 3" adjustment to riser

Part # 33-983.....12.98 ea

CLOSEOUT

Get genuine Red Korky+ while supplies last!



Toilet Repair

RED KORKY+ FLAPPER

Individually Boxed



Genuine **LAVELLE** 2001X

One-Piece Tank Flapper

Part # 33-461-BOX

1-49.....2.18 ea
50+.....1.98 ea

REPLACEMENT MOUNTING RING



- * Designed by a plumber with over 40 years experience in the field
- * Manufactured from rust-resistant 409 Stainless Steel for added strength and a long service life
- * Two-piece design allows easy replacement of an old rusty steel closet flange mounting ring
- * No major reconstruction of the existing plumbing or flooring needed

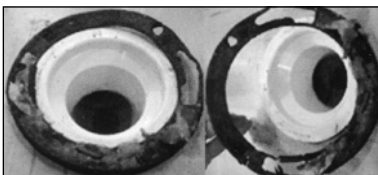

Remove the worn out steel ring

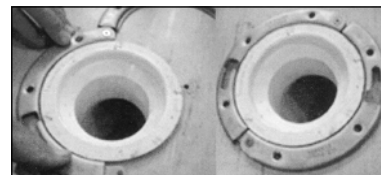

Replace with THE CLAM

Replacement Mounting Ring for ABS / PVC Closet Flanges

Part # 33-077.....9.96 ea



American Standard®
REPAIR PARTS
(47086-07)

Direct replacement
for the obsolete
#47086-07, complete
with lugs & screws



Part # 33-505.....38.76 ea

**for AMERICAN
STANDARD®**

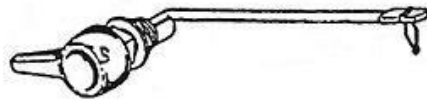

* Chrome with brass arm
* 5-1/2"



Part # 33-117.....4.98 ea

American Standard®
REPAIR PARTS

GENUINE
SOFT
RUBBER

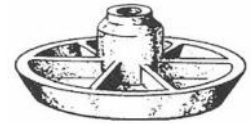

Snap On Disc

Part # 33-009.....2.98 ea

Screw On Disc

Part # 33-010.....2.98 ea

Mix & Match 24+.....2.88 ea

for AMERICAN STANDARD®

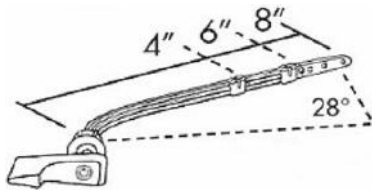

Neo 28° combo with
Plastic Arm, spud & nut

Part # 33-035.....6.98 ea



Plastic Arm, spud & nut
For Plebe and Cadet

Part # 33-038.....5.98 ea

American Standard®
REPAIR PARTS



Replaces Old Style
Tower Valve

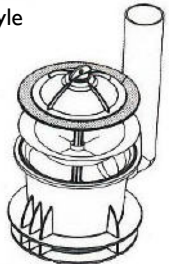

New Style Champion
Flush Valve Assembly

Part # 33-719.....39.88 ea

for American Standard®
REPAIR PARTS
(8321-07)

Chain kit complete
for all actuator units



Part # 33-168.....2.78 ea

American Standard®
REPAIR PARTS
(47107-0070A)

New Style Complete,
flush valve actuator
unit, white, short actuator

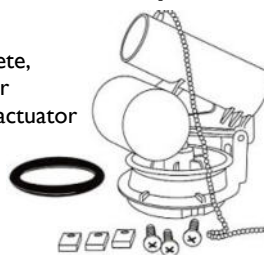

Part # 33-507.....38.88 ea

American Standard®
REPAIR PARTS

Flush
Valve
Seal
Only



Champion
Flush Valve Seal

Part # 33-722.....5.98 ea

American Standard®
REPAIR PARTS

#5 Complete Flush Valve,
tall black for standard
2-piece closets

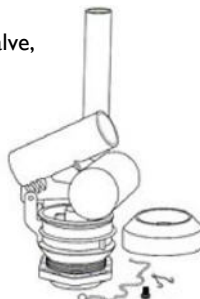

Part # 33-167.....22.88 ea

**for AMERICAN
STANDARD®**

Cadet Flush Right Flapper

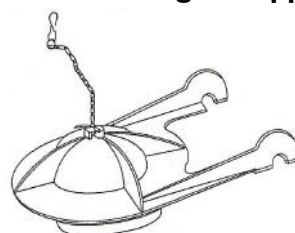

Packed 1 per box

Part # 33-980.....8.98 ea

American Standard®
REPAIR PARTS

Flush
Valve
Seal
Only

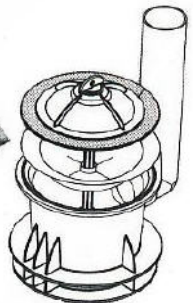

Flush Valve Seal for
New Style Champion
Flush Valve Assembly

Part # 33-331.....6.98 ea

for **KOHLER**
Big 3" Class 5



Packed 1 per box
(1078441)

Part # 33-897.....7.98 ea

for **KOHLER**
Cimarron Larger Size

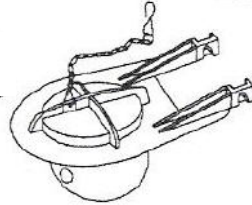

Packed 1 per box
(1039444)

Part # 33-891.....7.98 ea

for **KOHLER**
SS Royal Blue with Float

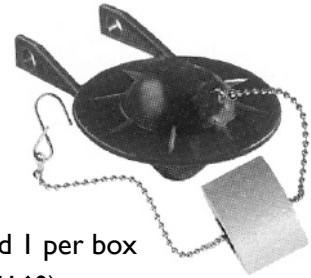

Packed 1 per box
(GP85160)

Part # 33-040.....6.88 ea

for **KOHLER**
Red "Shark"



Packed 1 per box

Part # 33-887.....6.98 ea

Need Genuine
KOHLER
Toilet Repair
Parts?

Send us your list!

KOHLER



Part # 33-227.....19.52 ea

for **KOHLER**
with Rim Diverter
(Generic)



Part # 33-031.....29.88 ea

KOHLER
Fill Valve Kit

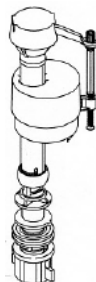

(GP1138930)

Part # 33-375.....17.98 ea

KOHLER

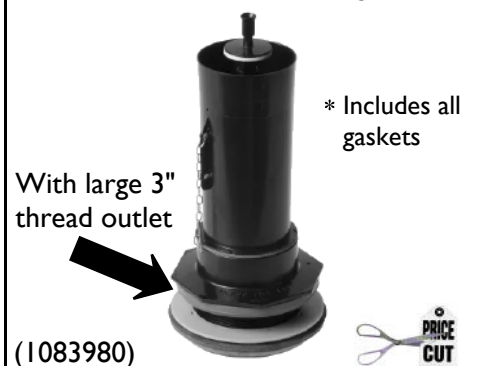

Part # 33-226.....22.88 ea

for **KOHLER**
Tank to Bowl Kit

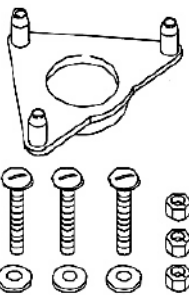

(GP51487)

Part # 33-299.....14.88 ea

for **KOHLER**
Tank to Bowl Kit



Soft Beveled Rubber
Washer with recess

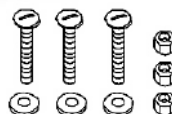

Part # 33-151.....12.88 ea

KOHLER
Canister Flush
Valve Seal



For Class Five & Class Six
with Canister Fill Valve

(GP1059291)

Part # 33-225

1-11.....6.98 ea
12+.....6.48 ea

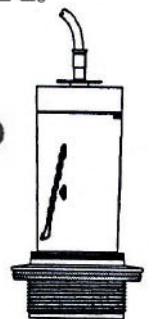

DIXIE COMBO MAKE-IT-FIT PRO TANK LEVER

ABS HANDLE WITH BRASS ARM

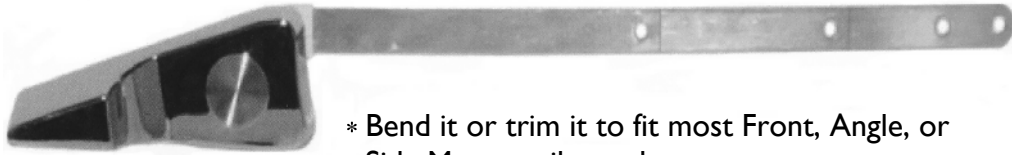

- * Bend it or trim it to fit most Front, Angle, or Side Mount toilet tanks
- * Great for commercial application
- * Available with chrome plated handle
- * Can also be cut to fit smaller/low-profile toilet tanks



Scored for cutting to 4" or 6" lever...



Bend lever to any form!

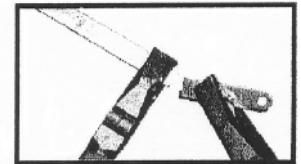

...or snap with pliers at appropriate score marks at 4" or 6"

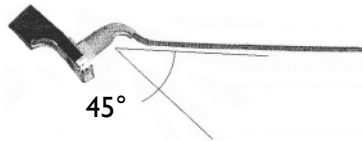

45°

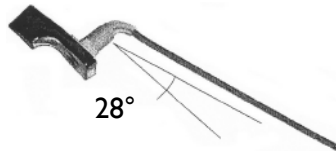

28°

Bend lever to any angle!



White Handle

Part # 33-135.....3.78 ea

Chrome Plated Handle

Part # 33-134.....3.98 ea

MAKE-IT-FIT PRO DESIGNER SERIES TANK LEVERS

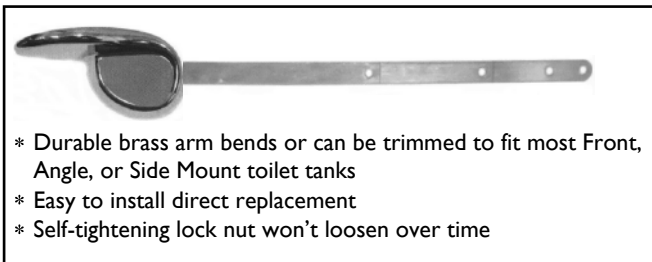

- * Durable brass arm bends or can be trimmed to fit most Front, Angle, or Side Mount toilet tanks
- * Easy to install direct replacement
- * Self-tightening lock nut won't loosen over time

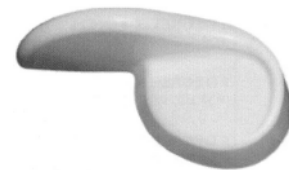

White Handle

Part # 33-609.....4.88 ea



Chrome Handle

Part # 33-601.....4.98 ea

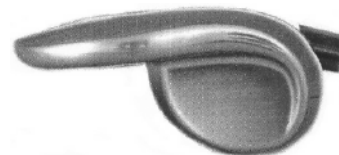

Satin Nickel Handle

Part # 33-604.....13.66 ea

TINY TIM HACKSAW



Vinyl Grip Handle
1/4" x 32 T blade

Part # 90-047.....4.98 ea

Tiny Tim Blade Refill
Pack of 10 blades

Part # 90-048...4.88 per pk



TOILET LEVELER SHIMS

- * 1/16" - 1/4" adjustable
- * Stackable
- * Easily trim to your desired height



Part # 33-384

Bag of 25..... .25¢ ea

Bag of 50..... .23¢ ea

Bag of 100..... .20¢ ea



SUPER SEAL TOILET LEVELER SHIMS

- * Perfect for toilets, vanities, mirrors and furniture

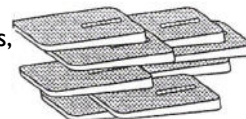

Packed in resealable zip bags of 25
Super Soft

Part #33-358..... .28¢ ea

Rigid

Part #33-359..... .28¢ ea

Flexible

Part #33-362..... .29¢ ea



FREE FLO 6" FORCE CUP



- * Preferred for all types of sinks, bowls & drains
- * 21" handle included

Part # 33-287

1-5.....7.48 ea

6+.....6.98 ea

EUREKA CLEAN OUT PLUG WRENCH

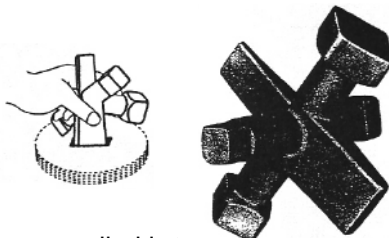

- * Strong, malleable iron
- * Fits slotted or square countersunk clean out plugs

Part # 90-098.....14.88 ea



for TOTO CHROME TANK LEVER



Chrome Plated Tank Lever

Part # 33-355.....6.38 ea



**CLASSIC STYLE UNIVERSAL TANK LEVER
DELUXE FORMED BRASS * CHROME FINISH**



- * Deluxe 8" Straight Brass Arm
- * All Metal Parts
- * Heavy Solid-Metal Nut with Rubber Washer
- * High Luster Chrome Finish

Part # 33-119

1-12.....4.48 ea

13+.....3.99 ea



for KOHLER TANK LEVER

Chrome Side Mount



Part # 33-021.....6.88 ea

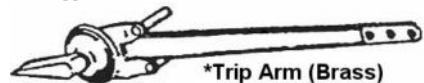

*Trip Arm (Brass)

Chrome Front Mount K9400

Part # 33-335.....14.98 ea

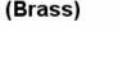

for ELJER CHROME SIDE MOUNT TANK LEVER

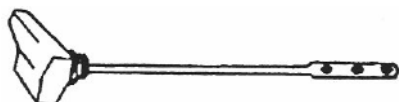

Part # 33-041.....4.98 ea

**MADE IN USA TANK LEVER
Chrome Finish**

- * Individually boxed
- * **Deluxe 8" Straight Brass Arm**
- * All Metal Parts
- * **Heavy Brass Nut**
- * High Luster Chrome Finish



Part # 33-113

1-12.....5.98 ea

13+.....5.48 ea



SPLIT-STYLE ESCUTCHEON

- * White plastic
- * Sure-grip style
- * Snaps over pipe for easy installation
- * Non-breakable
- * 100% rustproof
- * Packed 12 per box



- * Chrome-plated plastic
- * Sure-grip style
- * Snaps over pipe for easy installation
- * Non-breakable
- * 100% rustproof
- * Packed 12 per box



Fits 1/2" CTS or 3/8" IPS
Part # 51-616..... .23¢ ea
 Fits 3/4" CTS or 1/2" IPS
Part # 51-618..... .29¢ ea

Fits 1/2" CTS or 3/8" IPS
Part # 51-602..... .69¢ ea
 Fits 3/4" CTS or 1/2" IPS
Part # 51-604..... .79¢ ea

TEFLON TAPE



- * Standard Density (0.4) Thickness - 3.5 MIL
- * Meets Mil Spec T-27730A
- * Packaged 12 rolls per bag or 100 per box

1/2" x 260"
Part # 90-317..... .29¢ ea
 1/2" x 520"
Part # 90-318..... .39¢ ea

STOP SUPPLY TUBE ADAPTER

- * Converts 1/2 OD Supply to Regular 3/8 OD Supply Tube

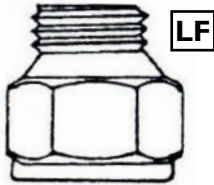

Part # 58-006AD
 Packed 1 per bag.....3.58 ea
 Packed 10 per bag.....3.28 ea

IPS X COMP ANGLE STOP

- * IPS x Comp Angle Stop
- * Solid Brass
- * Celcon Stem

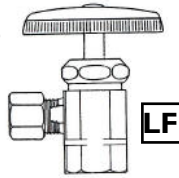

3/8 IPS X 3/8 OD
Part # 58-022.....4.88 ea
 1/2 FIP X 3/8 OD
Part # 58-021.....4.88 ea
 1/2 FIP X 1/2 OD
Part # 58-027.....6.88 ea

***** COMP X COMP ***
 *** ANGLE STOP *****

- * Comp x Comp Angle Stop
- * Solid Brass
- * Celcon Stem



5/8 OD X 3/8 OD
Part # 58-008.....4.88 ea
 5/8 OD x 1/2 OD
Part # 58-007.....5.98 ea

Black Swan PLUMBERS GREASE

- * Makes hard-turning faucets work smoothly
- * Lubricates stems of faucets, valves, ball cocks, etc.
- * Waterproof
- * Will not melt like ordinary grease
- * For hot water or steam



1 oz. tube
Part # 95-003.....3.28 ea

Let Dixie Plumbing Specialties and MAX Save You Time and Money!

Don't bother sitting in traffic or standing in line at a supply house.

We can make deliveries

every weekday to your door!

SAME DAY SHIPPING on orders placed by 1 p.m. ET

Visit www.dixieplumbingspecialties.com

to view our current specials!

To place an order, call 800-327-8531

or email info@dixieplumbingspecialties.com.



MAX

General PIPE CLEANERS

PROFESSIONAL CLOSET AUGERS

** SPECIAL AUGER FOR URINALS **

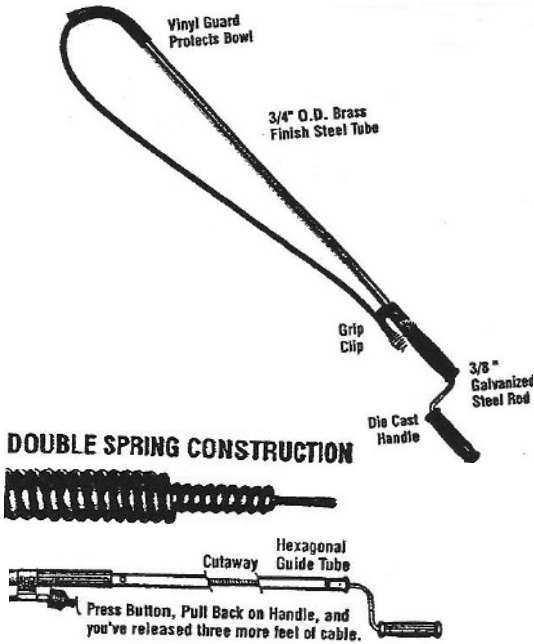

3 Foot Flexcore

3' Regular Head (3FL)

Part # 33-283-GA...46.98 ea

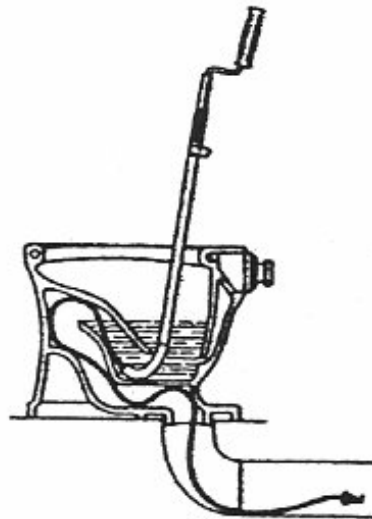

6 Foot Teletube

6' Regular Head (T6FL)

Part # 33-285-GA...69.88 ea



4' Telescoping Urinal Auger

Part # 90-700-GA....36.88 ea

WATER TEST GAUGE WITH INDICATOR

- * Steel Case with Large Shatterproof Face
- * 3/4" Brass Hose Connection
- * 300 lb. Pressure with Indicator

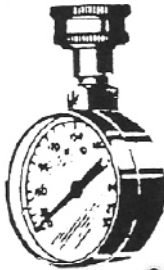

Part # 90-996.....14.98 ea

TOILET SEAT NUT WRENCH

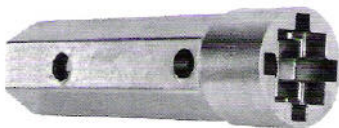

- * Fits any length bolt
- * Fits 99% of closet seat nuts
- * Die cast



Part # 90-626.....17.48 ea

LOOKING FOR ANY GENUINE

American[®] OR **KOHLER**[®]
Standard

TOILET REPAIR PARTS?



MAX

**WE'VE GOT YOU
COVERED!**

Give us a call
or send us your list!

"THE LAST DROP" TOILET SUCTION GUN

A MUST FOR EVERY PROFESSIONAL PLUMBER!

- * Removes water from toilet tanks
- * No drip canister holds water until you dispose of it
- * Flat suction end allows for complete draining
- * Bottom disc is removable for larger suction capacity
- * Also can be used in tubs, sinks & showers

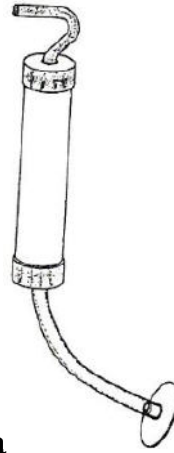

TOILET TANK LEAK DETECTOR TABLETS



- * Small blue dye tablet used to detect leaks in a toilet tank.
- * Drop tablet in toilet tank and if water in toilet bowl turns blue, a leak is present and repairs are needed.
- * Works quickly, showing results within minutes.
- * Contains FDA certified non-toxic dyes.
- * Packed 200 per bottle.

Part # 90-01731.98 ea

SOCKET SAVERS

- * Removes Schedule 40 PVC Pipe
- * Cuts ABS or PVC DWV pipe below slab
- * Fits 1/2" variable speed power drill
- * 1-1/2", 2", 3" or 4" sizes



Part # 90-024.....1 1/2".....10.88 ea
Part # 90-025.....2".....12.88 ea
Part # 90-026.....3".....15.88 ea
Part #90-027.....4".....24.88 ea

WATERPROOF OPEN MESH SAND CLOTH

- * 1-1/2" x 5 yd.
- * Open Mesh Pro Grit
- * Nylon Fabric
- * For Brass, Copper and Aluminum Fittings



Part # 95-104.....4.88 roll

Part # 95-061.....28.88 ea

BLUE SEAL! PROFESSIONAL GRADE PTFE THREAD SEAL TAPE



- * High strength
- * Twice the density of standard PTFE tape
- * Proven better than the competitors
- * 3.5 MIL thickness
- * Rugged multi-application product
- * Seals the most stubborn pipe threads

1/2" x 1,368" (1-24 each)
Part # 90-313.....2.88 per roll
 1/2" x 1,368" (Packed 25 rolls per box)
Part # 90-313.....2.68 per roll
 3/4" x 1,368" (1-14 each)
Part # 90-314.....3.86 per roll
 3/4" x 1,368" (Packed 15 rolls per box)
Part # 90-314.....3.73 per roll

CONFUSED ON THAT TOILET PART? SEND A PICTURE(S) TO MAX!

info@dixieplumbingspecialties.com

To best assist you, MAX needs to have:

1. Make of Toilet
2. ANY and ALL Numbers Stamped in the Lid of the Toilet and in the Tank Itself
3. A Picture of the Toilet
4. A Picture of the Inside of the Tank
5. A Picture of the Parts



NEED SLOAN®?

WE'VE GOT IT!

Give us a call, fax or email for any of your Genuine SLOAN needs.

SEND US YOUR LIST!

Regal • Royal • Optima • Sensor Faucets • Prison Valves

WE HAVE BETTER PRICING ON QUANTITY ORDERS OF SLOAN.

12+ 24+ 36+

CALL OR EMAIL YOUR REQUEST TO MAX

GENUINE SLOAN® PARTS



MAX SAYS



We are not allowed to advertise our best SLOAN Net Prices. You must call or email MAX to get your Special Quantity Order Price Quote.

info@dixieplumbingspecialties.com

SLOAN® HANDLE REPAIR KIT



Kit includes 1 each of : gasket A-31, plunger B-8-A, hycar seal B-39, delrin bushing B-40 and spring C-7.

Handle Repair Kit (B-50-A)
Part # 5302305.....3.39 ea

SLOAN® VACUUM BREAKER KIT



Vacuum Breaker Kit (V-551-A)
Part # 3323192.....3.19 ea

1.28 Gallon Closet Kit
For New Style LPF Toilets (A-140-A)
Part # 3301045.....21.50 ea

1.6 Gallon Closet Kit
For New Style LPF Toilets (A-41-A)
Part # 3301041.....21.50 ea

2.4 Gallon Closet Kit
For New Style LPF Toilets (A-44-A)
Part # 3301024.....21.50 ea

0.5 Gallon Urinal Kit
For New Style LPF Urinals (A-43-A)
Part # 3301081.....21.50 ea

1 Gallon Urinal Kit
For New Style LPF Urinals (A-42-A)
Part # 3301044.....21.50 ea



SLOAN®
VALVE COMPANY

SLOAN® REPAIR KITS

4.5 Gallon Closet Kit
For Old Style Toilets (A-36-A)
Part # 3301036.....21.50 ea

3.5 Gallon Closet Kit
For Old Style Toilets (A-38-A)
Part # 3301038.....21.50 ea

1.5 Gallon Urinal Kit
For Old Style Urinals (A-37-A)
Part # 3301037.....21.50 ea

SLOAN® SPECIAL O-RING

Packed 12 per bag



(H-553)
Part #5308696..... .69¢ ea

SLOAN®
SPUD & FLANGE KIT



3/4" (R-1008-A)
Part # 330807836.79 ea
1-1/2" (R-1010-A)
Part # 330808036.79 ea

SLOAN® VACUUM BREAKERS



3/4" x 9" Chrome
Part # 5323005.....27.11 ea
1-1/4" x 9" Chrome
Part # 5323006.....27.11 ea
1-1/2" x 9" Chrome
Part # 5323007.....27.11 ea
3/4" x 15" Chrome
Part # 0323210.....47.26 ea
1-1/2" x 15" Chrome
Part # 0323017.....44.33 ea
1-1/2" x 21-1/2" Chrome
Part # 0323015.....48.22 ea
1-1/2" x 26" Chrome
Part # 0323021.....56.55 ea

SLOAN®
SPUD NUT & FLANGE KIT



3/4" (F5A)
Part # 0306125.....16.74 ea
1-1/2" (F56A)
Part # 0306145.....16.74 ea

INTERNAL SPUD WRENCH

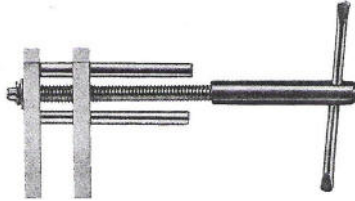

For removing brass spuds
Part # 90-086.....19.88 ea

BRASS URINAL & CLOSET SPUDS

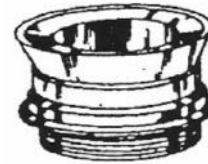

Cast brass, includes special treated rubber spud washers & metal friction rings

Urinal 1" x 3/4"
Part # 33-2147.98 ea
Closet 1-1/2" x 1-1/2"
Part # 33-2138.98 ea

SLOAN®
VANDAL RESISTANT STOP CAP



3/4" (H-1009-A)
Part # 330879012.19 ea
1" (H-1010-A)
Part # 330877212.19 ea

SLOAN®
ROYAL AND REGAL REPLACEMENT HANDLE COUPLING NUT



Chrome (A-6)
Part # 0301082PK ...6.92 ea

SLOAN®
HANDLE ASSEMBLY



Complete Handle (B-32-A)
Part # 530227916.02 ea

SLOAN®
VANDAL RESISTANT SOCKET CAP (SMALL) CHROME



* Packed 6 per bag
(H-1012-A)
Part # 5388001.....10.14 ea

SLOAN®
COMPLETE FLUSH VALVES
Your Choice
All at Same Price of \$134.99

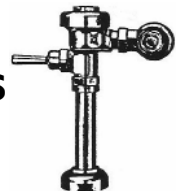

Sloan Closet Flush Valve
3.5 Gallon Flush
Part # 34-500 (old style)
Sloan Urinal Flush Valve
1.5 Gallon Flush
Part # 34-501 (old style)

Sloan Closet Flush Valve
1.6 Gallon Flush
Part # 34-502 (new lo-flow)
Sloan Urinal Flush Valve
1.0 Gallon Flush
Part # 34-503 (new lo-flow)

SLOAN®
DIAPHRAGM REPAIR KIT



(A-156-A)
Part # 5301188.....6.76 ea



SLOAN®
DIAPHRAGM REPAIR KIT



(A-156-AA)
Part # 530118913.91 ea

SLOAN®
STOP REPAIR KIT



3/4" Screwdriver Stop Kit
Part # 330885612.45 ea
1" Screwdriver Stop Kit
Part # 330885312.45 ea

**FLUSH VALVE
WALL BRACKET**



- * 1-1/2" OD size
- * 5" center of pipe to wall
- * Chrome plated split ring type
- * Mounting hardware included

Part # 34-512.....33.88 ea

**SLOAN® OPTIMA PLUS® SINGLE-FLUSH
OPTIMA SYSTEMS® RETROFIT SIDE MOUNT UNIT**

- * Converts handle-operated flush valve to sensor-operated
- * Installs in less than 5 minutes
- * No diaphragm to change
- * Works on both urinals and closet flush valves
- * Fits Sloan and Zurn flush valves
- * Chrome finish
- * Battery powered



Model EBV-500-A
Part # 34-507.....175.00 ea

SLOAN®
URINAL WATER FREE
CARTRIDGE



* Packed 1 per box
& 32 per case

(1001500)
Part # 34-19563.99 ea

SLOAN®
OUTSIDE COVER



Rough Brass Outside Cover (A-72)
Pt # 0301173PK...25.74 ea

Chrome Outside Cover (A-72)
Pt # 0301172PK...28.48 ea

SLOAN®
INSIDE COVER



Inside Cover (A-71)
Part # 03011688.88 ea



Max
Says:

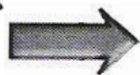

Need GENUINE SLOAN®

FLUSHMATE®

Replacement Parts?

CALL US!



SLOAN®
FLUSHMATE CARTRIDGE



(C-100500-KIT)
Part # 34-200.....36.44 ea

SLOAN®
PUSH BUTTON
REPAIR KIT



(C-70-A)
Part # 33033988.26 ea

SLOAN®
HYDRAULIC
ACTUATOR CARTRIDGE



(HY-83-A)
Part # 3318001.....30.52 ea

SLOAN®
ACTUATOR CARTRIDGE
ASSEMBLY



(HY-32-A)
Part # 031803155.45 ea

SLOAN®
CONCEALED WH
STOP REPAIR KIT 1"



(H-1006-A)
Part # 330886017.06 ea

SLOAN®
PERFORMANCE
HANDLE REPAIR KIT



(B-51-A)
Part # 33020036.59 ea

SLOAN®
PERFORMANCE
VACUUM BREAKER



(V-651-A)
Part # 33231833.39 ea

SLOAN®
SUPER WRENCH

This Genuine Sloan tool is designed to aid you in taking apart and repairing Sloan Flush Valves. This tool fits every connection required. It will also fit Delany Flush Valves.



(A-50)
Part # 90-019.....52.88 ea

SLOAN®
ROYAL DUAL-FILTERED DIAPHRAGM KITS



- * Patented dual-filter diaphragm prevents sediment from reaching the bypass, which prevents clogs and reduces water usage
- * Kit includes:
 - diaphragm
 - relief valve
 - disc
 - guide assembly

NEED ?



CALL US!

0.0125 Gallon Urinal Kit (A-1050-A)
Part # 3301143....37.99 ea

0.25 Gallon Urinal Kit (A-1047-A)
Part # 3301142....37.99 ea

0.5 Gallon Urinal Kit (A-1043-A)
Part # 3301124....37.99 ea

1.0 Gallon Urinal Kit (A-1042-A)
Part # 3301123.....37.99 ea

1.5 Gallon Urinal Kit (A-1037-A)
Part # 3301120.....37.99 ea

3.5 Gallon Closet Kit (A-1038-A)
Part # 3301121....37.99 ea

1.6 Gallon Closet Kit (A-1041-A)
Part # 3301122.....37.99 ea

2.4 Gallon Closet Kit (A-1044-A)
Part # 3301125....37.99 ea

1.28 Gallon Closet Kit (A-1045-A)
Part # 3301119.....37.99 ea

SLOAN® OPTIMA PLUS FLEX TUBE DIAPHRAGM KIT

Kit fits 1.6, 3.5, 4.5 Closet & 3.5 Urinals (EBV-1020-A)

Part # 3325001.....51.71 ea

Kit fits 2.4 Closet (EBV-1021-A)

Part # 3325014.....51.71 ea

Kit fits 1.0 and 1.5 Urinal (EBV-1022-A)

Part # 3325000.....51.71 ea

Kit fits 0.5 Urinal (EBV-1023-A)

Part # 3325003.....51.71 ea



Kit fits 1.28 Closet (EBV-1024-A)

Part # 3325031.....51.71 ea

Kit fits 0.125 and 0.25 Urinal (EBV-1025-A)

Part # 3325090.....51.71 ea

SLOAN® G2 MANUAL OVERRIDE BUTTON ASSEMBLY



(EBV-130-A)

Part # 0325172.....35.82 ea

SLOAN® G2 SOLENOID



(EBV-136-A)

Part # 3325453.....32.62 ea

SLOAN® G2 ELECTRONIC MODULE



For Closet (EBV-129 AC)

Part #3325450....187.66 ea

For Urinal (EBV-129 AU)

Part #3325451....187.66 ea

SLOAN® 8111 OPTIMA PLUS 1.6 CLOSET



CALL FOR
PRICING

Part # 3790011



SLOAN® VALVE COMPANY

GENUINE CLOSET/URINAL MASTER REPAIR KIT

Kit includes:

- * inside repair kit
- * handle repair kit
- * vacuum breaker repair kit
- * O-ring



SLOAN® REGAL PRISON FLUSH VALVES



CALL FOR
PRICING

NEW STYLE LOW-FLOW

0.5 Gal. Urinal Kit (R-1011-A)

Part # 34-494.....28.49 ea

1.0 Gal. Urinal Kit (R-1005-A)

Part # 34-497.....28.49 ea

2.4 Gal. Urinal Kit (R-1012-A)

Part # 34-496.....28.49 ea

1.6 Gal. Closet Kit (R-1004-A)

Part # 34-493.....28.49 ea

OLD STYLE HIGH-FLOW

1.5 Gal. Urinal Kit (R-1002-A)

Part # 34-499.....28.49 ea

3.5 Gal. Closet Kit (R-1003-A)

Part # 34-492.....28.49 ea

4.5 Gal. Closet Kit (R-1001-A)

Part # 34-498.....28.49 ea

Are you looking for....

****Genuine Plumbing Repair Parts****



American Standard

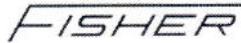

Fluidmaster.



Halsey Taylor.



MAX

Max says, "Genuine Parts work better!"

***** Email, Fax or Call us with your list. *****

WWW.DIXIEPLUMBINGSPECIALTIES.COM

- Handles
- Faucet Seats
- Flex Supplies
- Ball Valves
- Drain Chemicals
- Relief Valves
- Stems
- Spouts
- Tubular Brass
- Gate Valves
- Closet Seats
- O.E.M. Parts
- Trim
- Faucets
- Brass Fittings
- Thermocouples
- Parts
- Washers
- Stoppers
- Aerators
- Hangers
- Drains
- Commercial Parts
- Gaskets
- Flushometers
- Toilet Parts
- Augers
- Stem Lube
- Industrial Parts

OVER
25,000
ITEMS IN
STOCK

*** LOOKING FOR PLUMBING PARTS????**

Call MAX at 800-327-8531

email: info@dixieplumbingspecialties.com

WE SHIP
FAST!



Dixie Plumbing Specialties

P.O. Box 7237 Marietta, GA 30065

Telephone 770-973-8017

Toll Free USA 1-800-327-8531

Thousands
of Top Quality
Plumbing Parts
as close as
your Telephone.

State of the Art Plumbing Parts
Factory Direct Distributors

Direct Dial --
No Charge!

HARD TO FIND PLUMBING SPECIALTIES

PLEASE EMAIL OR FAX US YOUR PLUMBING REQUESTS