



# RESOURCES

## SOLID QUALITY. SOLID SERVICE.

PL0116-CATALOG

**BK Resources Cares About Conserving Water!**

# PLUMBING DIVISION FULL LINE CATALOG



**Hand Sinks with or without Faucet**

[More Information on Pg. 36-38](#)



**Convenience Store Sinks**

[More Information on Pg. 32](#)



**Grease Traps**

[More Information on Pg. 46-47](#)



**1 & 2 Year Warranty!**

**Splash Mount Faucets**

[More Information on Pg. 19-21](#)



**New Option!**

**Twist Lever Drains**

[More Information on Pg. 27](#)

**Deck Mount Faucets**

[More Information on Pg. 20-22](#)



**1 & 2 Year Warranty!**



**Metering Faucets**

[More Information on Pg. 6](#)

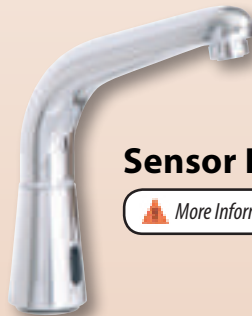

**Sensor Faucets**

[More Information on Pg. 7](#)

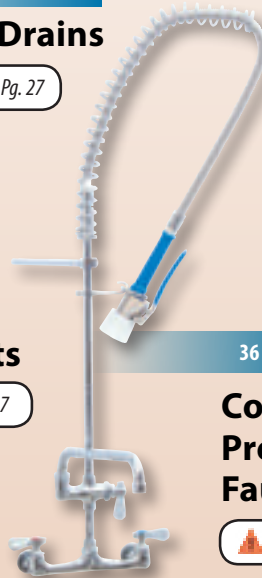

**Gas Hose Connection Kits**

[More Information on Pg. 1-4](#)



**36 Choices!**

**Commercial Pre-Rinse Faucets**

[More Information on Pg. 10-16](#)



**Dixie Plumbing Specialties, Inc.**  
Factory Direct Distributor

800-327-8531

[www.dixieplumbingspecialties.com](http://www.dixieplumbingspecialties.com)



**LEAD FREE**





## Dixie Plumbing Specialties, Inc. Factory Direct Distributor

800-327-8531

[www.dixieplumbingspecialties.com](http://www.dixieplumbingspecialties.com)

## Terms & Conditions

---

### **Payment Terms**

Net 30 days with approved credit or prepaid in advance.

### **Acceptable Credit Cards**

All Major Credit Cards Accepted.

### **Minimum Order Policy**

\$100.00 NET Minimum orders will only be accepted.

### **Ordering / Confirmations**

All orders will be acknowledged in writing and this acknowledgement constitutes our agreement with you regarding the items that are on your order. Please review this acknowledgement and return a signed copy by email or fax to confirm we have your order correct. No order will be entered without a signed acknowledgement returned.

### **F.O.B.**

All products are shipped F.O.B. Atlanta, Georgia.

### **U.P.S. Shipments**

Any item that is not intended to ship via U.P.S. is marked in the BK Resources catalog with a yellow shipping "Truck Line Only" tag by the product. If a customer chooses to ship this item by U.P.S., Dixie Plumbing Specialties will **NOT** file any freight claim on behalf of the customer.

### **Drop Shipments**

Dixie Plumbing Specialties will drop ship to any location, including residential addresses. Freight charges may be prepaid and added to your invoice if specified on shipments for locations other than the billing address. A \$10.00 drop ship fee will be charged for any orders being shipped to locations other than the billing address.

**NOTE:** Lift gate delivery service, special delivery notification, any inside deliveries and any other special delivery requirements will be subject to additional charges.

### **Freight Claims**

Before accepting any Dixie Plumbing Specialties shipment, examine it carefully and note any damages or shortages on the Freight Bill before signing for delivery. You should also have the driver sign the Freight Bill noting the damage or shortage. All reports of any damage, shortage or concealed damage must be reported to Dixie Plumbing Specialties within 48 hours of delivery. Retain all original packaging for claim purposes. Dixie Plumbing Specialties is not liable for any damage or loss that is not noted on the Freight Bill before accepting delivery or is not reported within 48 hours. Dixie Plumbing Specialties is also not responsible nor liable for the filing of any freight claims associated with any damaged merchandise that was shipped per the customers instructions via a Third Party or Collect.

### **Return Shipments**

Dixie Plumbing Specialties will not accept any returned merchandise unless prior authorization has been issued. All returned merchandise due to customer error are subject to a 25% restocking charge and must be in the original box, in new and unused condition. If any returned merchandise is not in the original box, in new and unused condition there will be no credit issued and the customer will be asked if they would like the merchandise returned to them at their expense. Any merchandise returned as being defective and no defect can be verified will incur a 25% handling fee as well as all freight charges for returning the merchandise and any freight charges for a replacement shipment.

**NOTE:** There will be no returns accepted after 90 days from date of shipment.

### **Warranty**

All BK Resources products come with a standard one (1) year Manufacturer's Warranty against any defects unless otherwise noted.



<b>After Market Side Splashes</b> .....	35
Single Removable Side Splash .....	35
Deep Fryer Side Splash .....	35
<b>Care &amp; Maintenance</b> .....	84
Cleaners - Polish - Set Screws .....	84
<b>Casters</b> .....	76-80
<b>Understanding Casters</b> .....	77
Expanding Stem Casters .....	80
Plate Mount Casters .....	78
Pop In Stem Casters .....	79
Threaded Stem Casters .....	79
<b>Commercial Gas Hoses</b> .....	1-4
<b>Compartment Sinks</b> .....	29-34
Budget Sinks & Detachable Drainboards .....	33
Convenience Store Sinks .....	32
Corner Compartment Sinks .....	31
Four Compartment Sinks .....	32
Mop Sink Kits & Soak Sinks .....	34
One Compartment Sinks .....	31
Stainless Steel Legs and End Bracing .....	30
Three Compartment Sinks .....	29
Two Compartment Sinks .....	30
<b>Dish Tables</b> .....	41-45
<b>Bundle &amp; Save</b> .....	41
Dish Tables, Clean & Soiled .....	42-43
Dish Table Accessories .....	44
Dish Table Kits .....	44
Three Compartment Soiled Dish Tables .....	41
Undercounter Dish Tables .....	45
<b>Drop In Sinks</b> .....	39-40
Drop In Ice Bins .....	40
Glass Filler Water Station .....	40
Removable Side Splash .....	39
Single, Double, Triple Drop In Sinks .....	39-40
<b>Fabricator Products</b> .....	85-92
Door Track & Sheaves .....	85
Drawer Assemblies .....	86
Equipment Legs .....	88
Fabricated Sink Bowls .....	91
Fabricator Supplies .....	92
Feet & Leg Sockets .....	89-90
Hardware Accessories .....	85-87
Hood Grease Filters .....	85
<b>Grease Traps</b> .....	46-47
Grease Trap Accessories .....	46
Steel Grease Traps .....	46-47
<b>Hand Sinks</b> .....	36-38
9" x 9" Space Saver Hand Sinks & Lead Free Packages .....	37
14" x 10" Hand Sinks & Lead Free Packages .....	36-37
16" x 20" Hand Sinks & Lead Free Packages .....	38
16" x 16" Hand Sinks .....	38
16" x 14" ADA Hand Sinks & Lead Free Packages .....	38
Pedestal Hand Sink .....	38

<b>Lead-Free Plumbing</b> .....	5-28
Drains .....	27-28
Faucets (Optiflow & Workforce) .....	20-22
Foot/Knee Valves .....	24
Imperial Series Pre-Rinse Units .....	10-13
Replacement Parts & Kits .....	17-18
Pantry Faucets .....	23
Pot Filler Units .....	26
Pre-Rinse Faucets, Parts & Accessories .....	14-16
Sensor & Metering Faucets .....	6-8
Spout Bases .....	24
Spouts & Specialty Faucets .....	18-19
Utility Spray Units .....	25
<b>New Products &amp; Coming Soon</b> .....	III-VI
<b>Shelving</b> .....	58-66
Aluminum Bun Pan Racks .....	63
Aluminum Dunnage Racks .....	66
Condiment/Spice Rack .....	58
Dish Cabinets .....	62
Microwave Shelves .....	58
Next Generation Wall Shelving .....	61
Overshelves .....	66
Point of Sale Work Station .....	58
Pot Racks (Ceiling Mount, Table Mount) .....	65
Slant Rack .....	58
Stainless Steel Wall Shelves .....	59-60
Utility Carts & Dry Storage Shelving Units .....	64
Wall Cabinets .....	62
Glass Rack Dollies .....	62
<b>Stainless Steel Tables</b> .....	67-75
Cabinet Base Work Tables .....	73
Drawer Assemblies .....	74
Equipment/Machine Stands .....	75
Filler Tables .....	72
T-430 Open Base Work Tables .....	69-70
Prep Tables .....	73
T-304 Stainless Steel Work Tables .....	71
T-430 Stainless Steel Work Tables w/ Undershef .....	67-68
<b>Tables &amp; Chairs</b> .....	81-83
Ladderback Chairs, Bar Stools & Seat Cushions .....	83
Laminated Table Tops .....	81
Metal Table Bases .....	82
Table Glides .....	83
<b>Underbar Equipment</b> .....	48-57
<b>18" Slim-Line Depth Equipment</b> Bar Sinks, Blender Stations with Sink, Drainboards & Dump Sinks .....	55-56
<b>21" Depth Equipment</b> Bar Sinks, Blender Stations with Sink, Drainboards & Dump Sinks .....	53-54
Bottle Well Holder .....	57
Glass Racks .....	57
Ice Bins 18" & 21" .....	53, 55
Ice Bins with Cold Plate 18" & 21" .....	53, 55
Ice Bin Lids 18" & 21" .....	53, 55
Liquor Display 18" & 21" .....	53, 55
Mobile Ice Bins .....	57
<b>Refrigeration</b> .....	48-51
Speed Rails .....	57
Work Stations .....	52

# New Products & Coming Soon

## CASTER KITS

6 new caster kits Coming Soon!

 More Information on Pg. 76

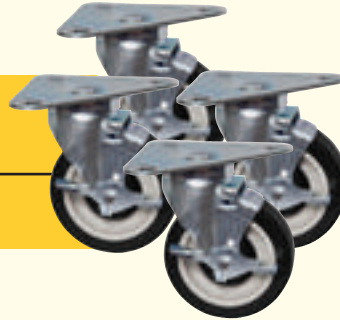

5HBR-TR5-PLY-PS4

5" Triangle Plate Caster Kit



3SBR-UP4-PLY-PS4

3" Universal Plate Caster Kit



Available end of January



All New Caster Kits  
Available in P.O.P. boxes



5HBR-UP4-PLY-PS4

5" Heavy Duty  
Universal Plate Caster Kit



3SBR-15ST-LDP-PS4

3" Threaded Stem Caster Kit



25SBR-4ST-LDP-PS4

2.5" Threaded Stem Caster Kit



3SBR-UP3AD-PLY-PS4

3" Adjustable Height  
Universal Plate Caster Kit

# New Products & Coming Soon



**BKHS-D-SS-SKTS / BKHS-D-1410-SKTS**  
Deck Mount Hand Sinks w/ Integrated  
Towel Dispenser

AVAILABLE  
NOW

More Information on Pg. 37

COMING  
SOON!

Available early February

**BKUBS-1014HS12S/BKUBS-1014HS12-18S**  
Space Saving Dump Sinks Now Available in 12"

More Information on Pg. 54 & 56



**BKUBS-1012TS**- Underbar Dump Sink with Integral  
Towel & Soap Dispenser Available in 18 - 21" Depth

More Information on Pg. 54 & 56

AVAILABLE  
NOW

AVAILABLE  
NOW

**BKUBDMX-18-21S**  
Underbar Mixing Station

More Information on Pg. 57



**AOBS-18/AOBS-12** - Add-On Blender  
Station for Underbar Equipment

More Information on Pg. 57

AVAILABLE  
NOW



# New Products & Coming Soon

AVAILABLE  
NOW

## Sensor Faucets & Accessories

 More Information on Pg. 7-8

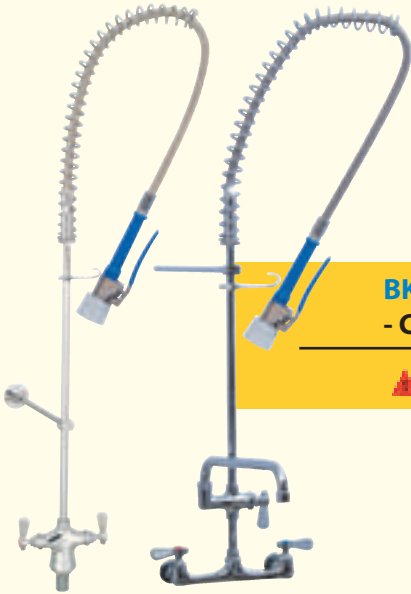

## BKF-CSPR-WB-G/BKF-CDPR-WB-G /BKF-SVSPR-WB-G - Commercial/Standard Imperial Pre-Rinse Faucets

 More Information on Pg.12-13

AVAILABLE  
NOW

## BK8D - 8" Deck Mount Workforce Faucet

 More Information on Pg. 20

AVAILABLE  
NOW



## BKSF-WB2 - Service Faucet w/ Vacuum Breaker

 More Information on Pg. 34

AVAILABLE  
NOW

AVAILABLE  
NOW

## BKG-XXSW - Swivel Pro Commercial Gas Hose Connector Available in 1/2", 3/4" and 1" Inside Diameter, Connection Kit featuring the Swivel Pro Also Available

 More Information on Pg. 1



# New Products & Coming Soon



**BK-ICT**  
Condiment/Spice Rack

AVAILABLE NOW

More Information on Pg. 58

AVAILABLE NOW

**BK-DIS-1620-3ME** - 3 Compartment Drop-In Sink w/ Marine Edge

More Information on Pg. 40



**BK-DIS-1014-3-12T** - Drop-In Sink w/ Marine Edge on All 4 Sides w/ Raised Faucet Ledge

More Information on Pg. 40

AVAILABLE NOW

AVAILABLE NOW

**BK-AG** - Self-Leveling Table Glides

More Information on Pg. 83

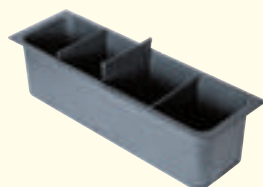

**BK-IBBH/IBBH18** - Bottle Well Holders for 18" and 21" cold Plate/Ice Bin

More Information on Pg. 57

AVAILABLE NOW

# TIRED OF THE BLUES? TIME TO MAKE A BRIGHTER CHOICE.

WARRANTED  
5 YEARS



Meets ANSI Codes:

- Z21.69a
- Z21.69b
- Z21.69-2002
- Z21.41a-2005
- Z21.41b-2010
- Z21.41-2003



# swivel PRO™

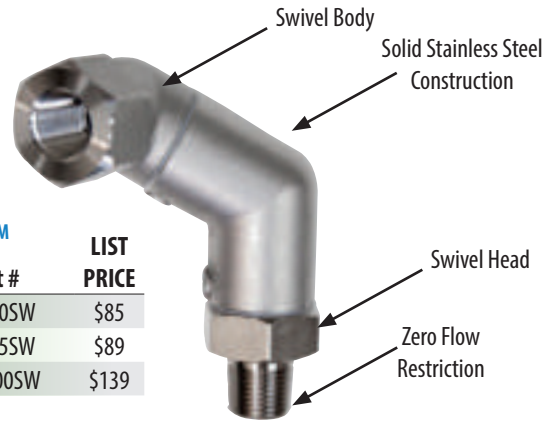

Size	Part #	LIST PRICE
1/2"	BKG-50SW	\$85
3/4"	BKG-75SW	\$89
1"	BKG-100SW	\$139



Packaged in POP Box

**New & In Stock!**  
**Swivel Pro™**  
Does not restrict flow!  
2 points of 360° Rotation!  
Available Individually  
or in SW3 Kits!



Packaged in POP Box

### Swivel Pro™ Connection Kit

Inside Diameter	Length	Gas Hose & Hardware	LIST PRICE
1/2"	24"	BKG-GHC-5024-SW3	\$247
1/2"	36"	BKG-GHC-5036-SW3	\$255
1/2"	48"	BKG-GHC-5048-SW3	\$263
1/2"	60"	BKG-GHC-5060-SW3	\$289
1/2"	72"	BKG-GHC-5072-SW3	\$313
3/4"	24"	BKG-GHC-7524-SW3	\$309
3/4"	36"	BKG-GHC-7536-SW3	\$315
3/4"	48"	BKG-GHC-7548-SW3	\$333
3/4"	60"	BKG-GHC-7560-SW3	\$369
3/4"	72"	BKG-GHC-7572-SW3	\$391
1"	24"	BKG-GHC-10024-SW3	\$413
1"	36"	BKG-GHC-10036-SW3	\$419
1"	48"	BKG-GHC-10048-SW3	\$445
1"	60"	BKG-GHC-10060-SW3	\$493
1"	72"	BKG-GHC-10072-SW3	\$511

### 2x Swivel Pro™ Connection Kit

Inside Diameter	Length	Gas Hose & Hardware	LIST PRICE
1/2"	24"	BKG-GHC-5024-2SW3	\$332
1/2"	36"	BKG-GHC-5036-2SW3	\$340
1/2"	48"	BKG-GHC-5048-2SW3	\$348
1/2"	60"	BKG-GHC-5060-2SW3	\$374
1/2"	72"	BKG-GHC-5072-2SW3	\$398
3/4"	24"	BKG-GHC-7524-2SW3	\$398
3/4"	36"	BKG-GHC-7536-2SW3	\$404
3/4"	48"	BKG-GHC-7548-2SW3	\$422
3/4"	60"	BKG-GHC-7560-2SW3	\$458
3/4"	72"	BKG-GHC-7572-2SW3	\$480
1"	24"	BKG-GHC-10024-2SW3	\$552
1"	36"	BKG-GHC-10036-2SW3	\$558
1"	48"	BKG-GHC-10048-2SW3	\$584
1"	60"	BKG-GHC-10060-2SW3	\$632
1"	72"	BKG-GHC-10072-2SW3	\$650







Custom Kit for the Professional Plumber

WARRANTED 5 YEARS  
C SP US

Packaged in POP Box

### Gas Hose Connection Kit #2

Inside Diameter	Length	Gas Hose & Hardware	LIST PRICE
1/2"	24"	BKG-GHC-5024-SCK2	\$142
1/2"	36"	BKG-GHC-5036-SCK2	\$150
1/2"	48"	BKG-GHC-5048-SCK2	\$158
1/2"	60"	BKG-GHC-5060-SCK2	\$184
1/2"	72"	BKG-GHC-5072-SCK2	\$208
3/4"	24"	BKG-GHC-7524-SCK2	\$192
3/4"	36"	BKG-GHC-7536-SCK2	\$198
3/4"	48"	BKG-GHC-7548-SCK2	\$216
3/4"	60"	BKG-GHC-7560-SCK2	\$252
3/4"	72"	BKG-GHC-7572-SCK2	\$274
1"	24"	BKG-GHC-10024-SCK2	\$232
1"	36"	BKG-GHC-10036-SCK2	\$238
1"	48"	BKG-GHC-10048-SCK2	\$264
1"	60"	BKG-GHC-10060-SCK2	\$312
1"	72"	BKG-GHC-10072-SCK2	\$330



WARRANTED 5 YEARS  
C SP US

Packaged in POP Box

### Gas Hose Connection Kit #3

Inside Diameter	Length	Gas Hose & Hardware	LIST PRICE
1/2"	24"	BKG-GHC-5024-SCK3	\$162
1/2"	36"	BKG-GHC-5036-SCK3	\$170
1/2"	48"	BKG-GHC-5048-SCK3	\$178
1/2"	60"	BKG-GHC-5060-SCK3	\$204
1/2"	72"	BKG-GHC-5072-SCK3	\$228
3/4"	24"	BKG-GHC-7524-SCK3	\$220
3/4"	36"	BKG-GHC-7536-SCK3	\$226
3/4"	48"	BKG-GHC-7548-SCK3	\$244
3/4"	60"	BKG-GHC-7560-SCK3	\$280
3/4"	72"	BKG-GHC-7572-SCK3	\$302
1"	24"	BKG-GHC-10024-SCK3	\$274
1"	36"	BKG-GHC-10036-SCK3	\$280
1"	48"	BKG-GHC-10048-SCK3	\$306
1"	60"	BKG-GHC-10060-SCK3	\$354
1"	72"	BKG-GHC-10072-SCK3	\$372



WARRANTED 5 YEARS  
C SP US

Packaged in POP Box

### Gas Hose Connection Kit #9

Inside Diameter	Length	Gas Hose & Hardware	LIST PRICE
1/2"	24"	BKG-GHC-5024-SCK9	\$166
1/2"	36"	BKG-GHC-5036-SCK9	\$174
1/2"	48"	BKG-GHC-5048-SCK9	\$182
1/2"	60"	BKG-GHC-5060-SCK9	\$208
1/2"	72"	BKG-GHC-5072-SCK9	\$232
3/4"	24"	BKG-GHC-7524-SCK9	\$224
3/4"	36"	BKG-GHC-7536-SCK9	\$230
3/4"	48"	BKG-GHC-7548-SCK9	\$248
3/4"	60"	BKG-GHC-7560-SCK9	\$284
3/4"	72"	BKG-GHC-7572-SCK9	\$306
1"	24"	BKG-GHC-10024-SCK9	\$278
1"	36"	BKG-GHC-10036-SCK9	\$284
1"	48"	BKG-GHC-10048-SCK9	\$310
1"	60"	BKG-GHC-10060-SCK9	\$358
1"	72"	BKG-GHC-10072-SCK9	\$376

### Gas Hose Connection Kit Parts List



Swivel Pro™



90° Female Elbows



Threaded Nipples



Restraining Cable & Hardware



Shut-Off Ball Valve



Quick Disconnect



90° Street Elbows



# GAS HOSES PACKAGED IN P.O.P. MERCHANDISING PLASTIC TUBE

New Kit Available!



Packaged in Plastic Tube



## Gas Hose Quick Disconnect Connection Kit

Inside Diameter	Length	Gas Hose & Hardware	LIST PRICE
1/2"	24"	BKG-GHC-5024-QD-PT	\$130
1/2"	36"	BKG-GHC-5036-QD-PT	\$138
1/2"	48"	BKG-GHC-5048-QD-PT	\$144
1/2"	60"	BKG-GHC-5060-QD-PT	\$168
1/2"	72"	BKG-GHC-5072-QD-PT	\$190
3/4"	24"	BKG-GHC-7524-QD-PT	\$180
3/4"	36"	BKG-GHC-7536-QD-PT	\$186
3/4"	48"	BKG-GHC-7548-QD-PT	\$202
3/4"	60"	BKG-GHC-7560-QD-PT	\$236
3/4"	72"	BKG-GHC-7572-QD-PT	\$256
1"	24"	BKG-GHC-10024-QD-PT	\$220
1"	36"	BKG-GHC-10036-QD-PT	\$226
1"	48"	BKG-GHC-10048-QD-PT	\$250
1"	60"	BKG-GHC-10060-QD-PT	\$296
1"	72"	BKG-GHC-10072-QD-PT	\$312

## GAS HOSE ONLY in POP Merchandising Plastic Tube

Inside Diameter	Length	Gas Hose & P.O.P Display Tube	LIST PRICE
1/2"	24"	BKG-GHC-5024-PT	\$100
1/2"	36"	BKG-GHC-5036-PT	\$110
1/2"	48"	BKG-GHC-5048-PT	\$122
1/2"	60"	BKG-GHC-5060-PT	\$148
1/2"	72"	BKG-GHC-5072-PT	\$170
3/4"	24"	BKG-GHC-7524-PT	\$128
3/4"	36"	BKG-GHC-7536-PT	\$146
3/4"	48"	BKG-GHC-7548-PT	\$168
3/4"	60"	BKG-GHC-7560-PT	\$192
3/4"	72"	BKG-GHC-7572-PT	\$218
1"	24"	BKG-GHC-10024-PT	\$148
1"	36"	BKG-GHC-10036-PT	\$150
1"	48"	BKG-GHC-10048-PT	\$174
1"	60"	BKG-GHC-10060-PT	\$208
1"	72"	BKG-GHC-10072-PT	\$240



Packaged in Plastic Tube



## ANSI Z21.69 STATES:

Caster mounted equipment shall be installed with a restraining device, which prevents the transmission of stress to the hose.

## Shut-Off "Ball-Valve"

Required by code to allow for manual shut-off of gas within six feet of appliance.



Size	Part #	LIST PRICE
1/2"	BKG-BV50	\$16
3/4"	BKG-BV75	\$22
1"	BKG-BV100	\$34

## Quick Disconnect

Easily connects and disconnects gas hose from wall and or appliance for equipment maintenance and cleaning. ANSI Z21.41.2003



Size	Part #	LIST PRICE
1/2"	BKG-QDC-50	\$44
3/4"	BKG-QDC-75	\$62
1"	BKG-QDC-100	\$90

## Restraining Cable Kit

Secures appliance from exceeding recommended distance from wall. ANSI Z21.69b



Fits Hose Length	Part #	LIST PRICE
24"	BKG-RCK-24	\$12
36"	BKG-RCK-36	\$12
48"	BKG-RCK-48	\$14
60"	BKG-RCK-60	\$16
72"	BKG-RCK-72	\$18

## 90° Male to Female Fitting



Size	Part #	LIST PRICE
1/2"	BKG-90E50	\$4
3/4"	BKG-90E75	\$6
1"	BKG-90E100	\$8



**Individual Gas Hose**

Inside Diameter	Length	PVC Gas Hose	LIST PRICE
1/2"	24"	BKG-GHC-5024	\$90
1/2"	36"	BKG-GHC-5036	\$100
1/2"	48"	BKG-GHC-5048	\$110
1/2"	60"	BKG-GHC-5060	\$136
1/2"	72"	BKG-GHC-5072	\$156
3/4"	24"	BKG-GHC-7524	\$118
3/4"	36"	BKG-GHC-7536	\$132
3/4"	48"	BKG-GHC-7548	\$152
3/4"	60"	BKG-GHC-7560	\$174
3/4"	72"	BKG-GHC-7572	\$198
1"	24"	BKG-GHC-10024	\$136
1"	36"	BKG-GHC-10036	\$150
1"	48"	BKG-GHC-10048	\$174
1"	60"	BKG-GHC-10060	\$208
1"	72"	BKG-GHC-10072	\$240

**"FREE" GAS HOSE DISPLAY RACKS**



**36" Gas Hose Display Rack**  
Holds 24 Gas Hose Kits  
(BK-GHR-36)

**48" Gas Hose Display Rack**  
Holds 32 Gas Hose Kits  
(BK-GHR-48)

**Build Your Own 36" Gas Hose Kit Display Rack**  
Receive A Free 36" Display Rack with the purchase of 24 POP Gas Hose Kits.

**Build Your Own 48" Gas Hose Kit Display Rack**  
Receive A Free 48" Display Rack with the purchase of 32 POP Gas Hose Kits.

**Build Your Own Mobile Stand Kit**  
Receive A Free Mobile Stand with the purchase of 16 individual hoses.

*(1) 36" or 48" gas hose kit display rack and (1) mobile stand kit per customer*

**Meets ANSI Codes:**

- Z21.69a
- Z21.69b
- Z21.69-2002
- Z21.41a-2005
- Z21.41b-2010
- Z21.41-2003



**Mobile Stand Kit**  
Holds 16 ea. Gas Hoses  
(BK-GHMR)

# LEAD FREE Plumbing & Certifications

## ANSI 372 Compliant

**LEAD FREE**

 Certified to NSF/ANSI 61  
Section 9-G

**BK Resources has complied with and has been certified by:**

NSF International to ANSI/NSF Standard 61 Section 9, Drinking Water System Components – Health Effects. NSF International evaluated both the leaching of contaminants into drinking water from faucets.

Simply look for the  logo accompanied by the “NSF 61 Section 9” logo in our literature.

## Plumbing Warranties

### Heavy & Standard Duty Plumbing

Simply look for these logos throughout our literature to determine the warranty that applies for each product.

### Which Option is Better for Your Facility?

**workFORCE**  
SERIES

• Standard Duty has a 1 Year Warranty

**ptiFlow™**  
SERIES

• Heavy Duty has a 2 Year Warranty

**sur-FL**  
SERIES

• Standard Duty has a 3 Year Warranty

**Heavy Duty**
**ptiFlow™**  
SERIES

- Built for High Volume Environments
- Heavier Faucet Body
- Longer Lasting Material
- More Durable Valve

**or**

**Standard Duty**
**workFORCE**  
SERIES

- Built for Low Volume Environments
- Thinner Faucet Body
- Economically Friendly



# New Metering Faucets Now Available!

**LEAD FREE**  
ANSI 372 Compliant



**BKF-4MFD-G - 4" Deck Mounted Hot and Cold Water Lead Free Metering Faucet**

- 4" Fixed Center Two Hole Polished Chrome Plated Metering Faucet
- 2" Center to Center Integral Cast Brass Spout

Part Number	LIST PRICE
BKF-4MFD-G	\$249



**BKF-8MFD-G - 8" Deck Mounted Hot and Cold Water Lead Free Metering Faucet**

- 8" Fixed Center Two Hole Polished Chrome Plated Metering Faucet
- 4" Center to Center Integral Cast Brass Spout

Part Number	LIST PRICE
BKF-8MFD-G	\$339



**BKF-1SMFD-G - Deck Mounted Single Supply Lead Free Metering Faucet**

- Single Hole Polished Chrome Plated Metering Faucet
- 3-3/8" Center to Center Integral Cast Brass Spout

Part Number	LIST PRICE
BKF-1SMFD-G	\$145

## Replacement Parts For Metering Faucets

Part Number	LIST PRICE
1 MFD-AA Actuator Assembly	\$40
2 MFD-MV Metering Valve Cartridge	\$30



MFD-AA



MFD-MV

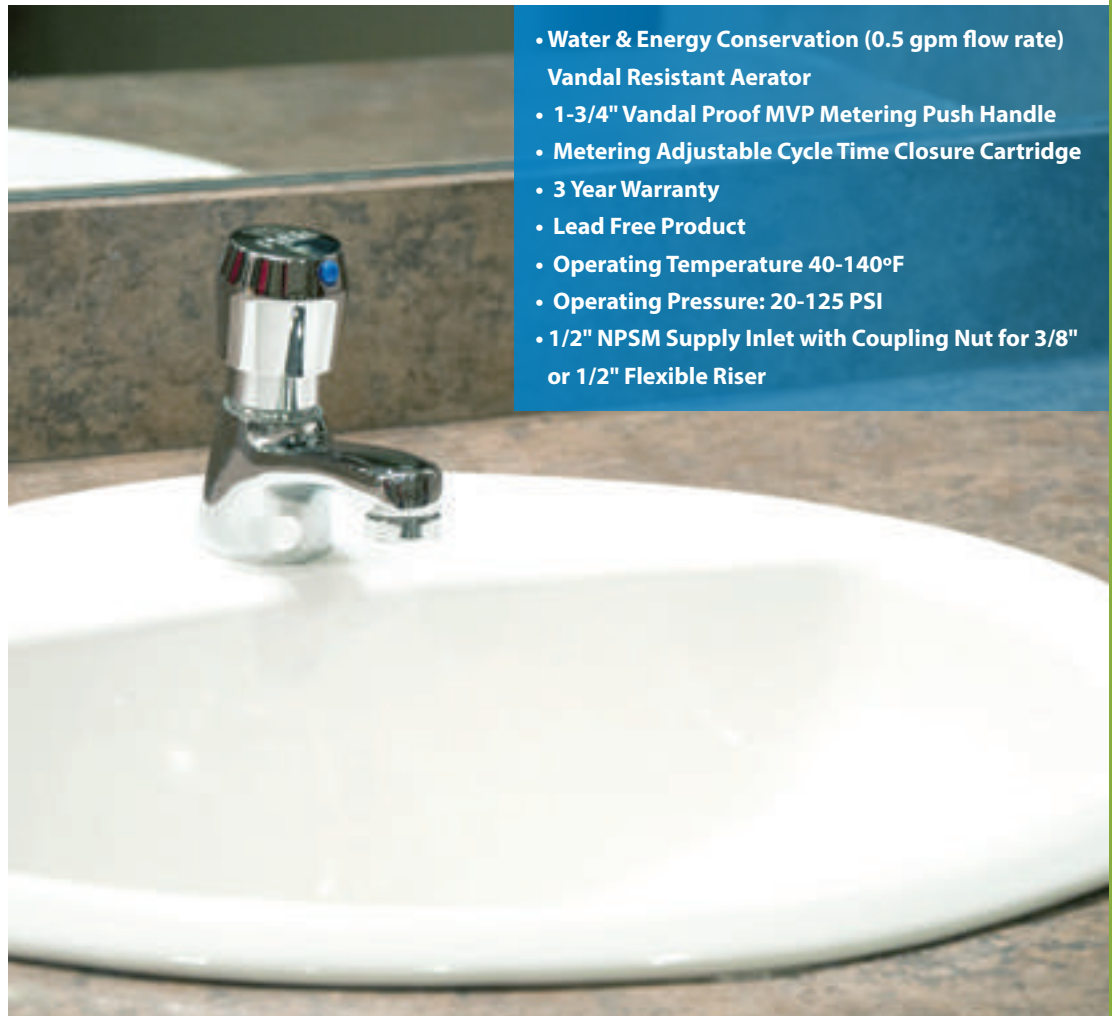

- Water & Energy Conservation (0.5 gpm flow rate)
- Vandal Resistant Aerator
- 1-3/4" Vandal Proof MVP Metering Push Handle
- Metering Adjustable Cycle Time Closure Cartridge
- 3 Year Warranty
- Lead Free Product
- Operating Temperature 40-140°F
- Operating Pressure: 20-125 PSI
- 1/2" NPSM Supply Inlet with Coupling Nut for 3/8" or 1/2" Flexible Riser



**Did You Know?**

According to the EPA, 31% of water used by restaurant or food service establishments takes place in restrooms. For more info, go to [www.epa.gov/watersense](http://www.epa.gov/watersense).

- Water & Energy Conservation (0.5 gpm flow rate)
- Minimum Sensor Range: 3 5/32"
- Maximum Sensor Range: 11 13/16"
- 2 Year Warranty
- Lead Free Product
- Maximum Operating Temperature 40-158°F
- Operating Pressure: 7-100 PSI
- Security Time: The faucet will shut down automatically after 90 sec.
- Single Hole Chrome Plated Touch Free Faucet for Cold or Premixed Water



BKF-JET-G



See Page 8 for details.

**BKF-JET-G - Jet Faucet**

- Available with a 9V Battery or a 9V Transformer
- Adjustable Sensor Settings by Remote Control (Sold Separately)



Part Number	Power Supply	LIST PRICE
BKF-JET-9B-G	Battery	\$500
BKF-JET-9T-G	Transformer	\$500
BKF-JET-9H-G	Hardwire	\$520



BKF-KAI-G



See Page 8 for details.

**BKF-KAI-G - Kai Faucet**

- Available with a 9V Battery or a 9V Transformer
- Adjustable Sensor Settings by Remote Control (Sold Separately)



Part Number	Power Supply	LIST PRICE
BKF-KAI-9B-G	Battery	\$510
BKF-KAI-9T-G	Transformer	\$510
BKF-KAI-9H-G	Hardwire	\$530



BKF-CAS-G

**BKF-CAS-G - Cascade Faucet**

- Integrated Plate to Cover Existing Holes
- Dual Power Input Box Unit that Allows Operating the Integrated Battery Backup, for Normal Use During Power Supply Failures, when a 9V Battery is Added (Lithium Battery Recommended)



Part Number	Power Supply	LIST PRICE
BKF-CAS-9B-G	Battery	\$520
BKF-CAS-9T-G	Transformer	\$520
BKF-CAS-9H-G	Hardwire	\$548

**Splash/Deck Mount Electronic Faucet**



SHOWN AS: BKF-SEF-3G

- 3 1/2" Gooseneck Spout
- Adjustable Temp. Setting
- Optional Low-Flow Aerator

- Battery or Plug-In Power Supply Options

Part Number	Spout Mounting	LIST PRICE
BKF-SEF-3G	Splash	\$494
BKF-DEF-3G	Deck	\$494



SHOWN AS: BKF-DEF-3G

# Sensor Faucet Accessories



**06530008**  
Battery Box Without Battery (Female)  
LIST PRICE **\$23.00**

**06530018**  
Battery Box Without Battery (Male)  
LIST PRICE **\$23.00**



**07040076**  
4 in. Cover Deck Plate  
LIST PRICE **\$25.00**



**07100005**  
Remote Control Unit  
LIST PRICE **\$35.00**



**06009010**  
10 ft Extension Cable (Female to Male)  
LIST PRICE **\$45.00**



**BKSF-9V**  
9 Volt Battery  
LIST PRICE **\$8.00**



**06001005**  
3-Way Power Splitter (1 Female to 3 Male)  
LIST PRICE **\$27.00**

**06001002**  
3-Way Power Splitter (1 Male to 3 Female)  
LIST PRICE **\$27.00**



**06001001**  
2-Way Power Splitter (1 Male to 2 Female)  
LIST PRICE **\$22.00**

**06001004**  
2-Way Power Splitter (1 Female to 2 Male)  
LIST PRICE **\$22.00**



**06522065**  
IP68 US Hardwire Transformer (Female)  
LIST PRICE **\$48.00**

**06522070**  
IP68 US Hardwire Transformer (Male)  
LIST PRICE **\$48.00**



With Hardwires



**06522090**  
9 Volt US Plug-In Transformer (Female)  
LIST PRICE **\$23.00**

**06522092**  
9 Volt US Plug-In Transformer (Male)  
LIST PRICE **\$23.00**

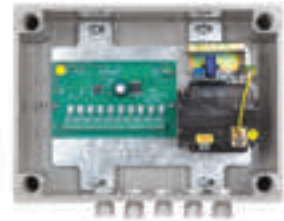

**06530013**  
Transformer Junction Box  
LIST PRICE **\$389.00**



**06000084**  
9.8 Junction Box Connector (Female)  
LIST PRICE **\$24.00**

**06000086**  
9.8 Junction Box Connector (Male)  
LIST PRICE **\$24.00**

**06000049**  
16.4 Junction Box Connector (Female)  
LIST PRICE **\$34.00**

**06000063**  
16.4 Junction Box Connector (Male)  
LIST PRICE **\$34.00**

**06000166**  
26.2 Junction Box Connector (Female)  
LIST PRICE **\$47.00**

**06000183**  
26.2 Junction Box Connector (Male)  
LIST PRICE **\$47.00**

## BK Resources Cares About Conserving Water

Use Less Water by Adding our  **LOW FLOW Aerator\*** (\$19 List Price) to Any BK Resources Faucet **OR** Change a Pre-Rinse to Low Flow by adding our  **LOW FLOW Spray Head** (\$79 List Price)!



BK-PRV-1-G  
(See page 14)



BK-F-C414-VR  
(See page 18 or 28)

## WHY LOW FLOW?



**Less Than 1 Gallon Per Minute**

### Standard vs. Low Flow Aerator Water Consumption Differences

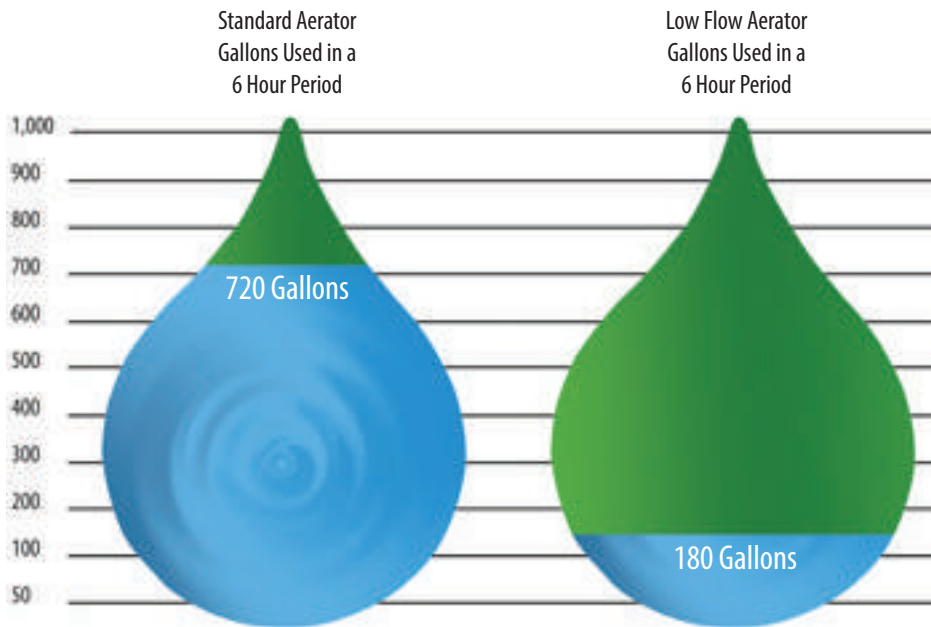

540 Gallons Saved = 75% Difference



**Every Drop Counts!**

## Did You Know?

- According to circleofblue.org, there has been a 41% rise in water costs since 2010.
- According to the EPA, "About 970,000 food service establishments in the United States use approximately 51 billion gallons of water each year to rinse dishes with pre-rinse spray valves." For more info, go to [www.epa.gov/watersense](http://www.epa.gov/watersense).
- According to the EPA, restaurant and food service businesses make up around 15% of the total commercial water consumption in the United States. 52% of that water consumption is being used in the kitchen and during the dishwashing process.

**NOTE: (\*) Assembly Required. Aerator does not come attached. The aerator must be added to the Pre-Rinse units with an Add-a-Faucet to create the Low Flow option.**





# Imperial Series

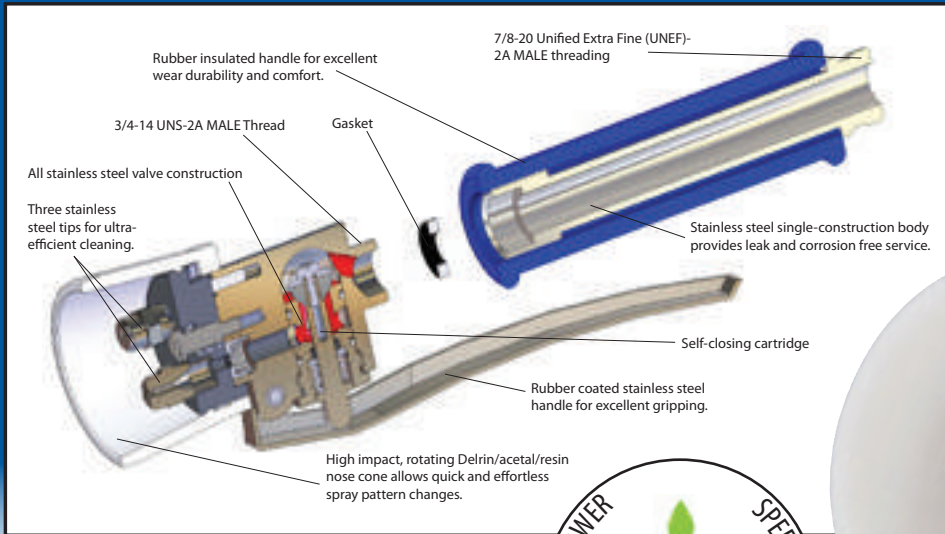

## Imperial Series

- **Water and Energy Conservation** (< .99 gpm flow rate)
- **Fastest Clean Time** (independent test by Food Service Technology Center)
- **Highest User Satisfaction** (testing by EPA WaterSense field study)
- **5 Year Warranty** (longest in the industry)
- **3 Different Spray Patterns** with Every Unit
- **All Stainless Steel Construction** (lead free)
- **NRA Kitchen Innovation Award** Winning Product
- **Endorsed by Green Restaurant Association**
- **Interchangeable with All Major Faucet Brands**

### Spray Pattern Choices



#### Solid Stream Tip

Flow Rate: 0.99 gpm @ 60 psi  
Description: Solid spray pattern with high impact for tough cleaning applications.



#### Fan Spray Tip

Flow Rate: 0.92 gpm @ 60 psi  
Description: 5° fan spray for general cleaning applications.



#### Fan Spray Tip

Flow Rate: 0.91 gpm @ 60 psi  
Description: 15° fan spray for general cleaning applications.





# Imperial Series

## INDUSTRIAL

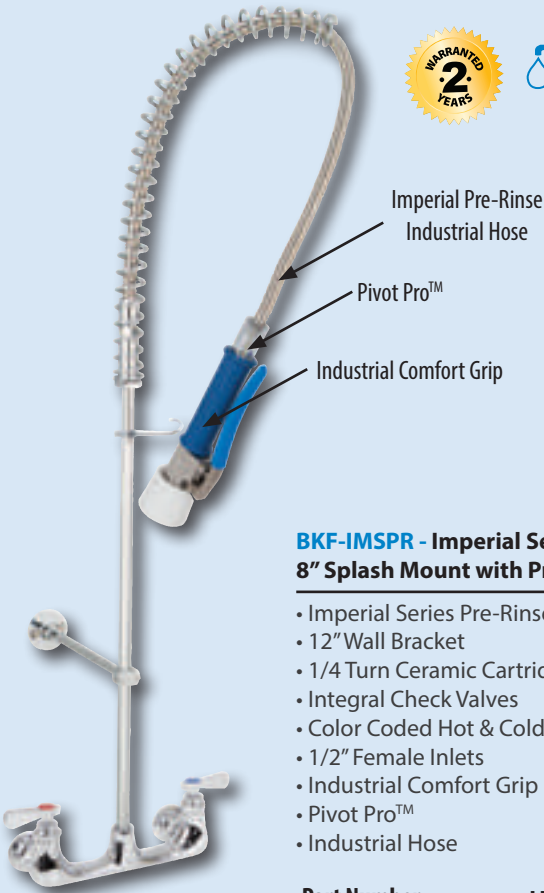

### BKF-IMSPR - Imperial Series Industrial 8" Splash Mount with Pre-Rinse

- Imperial Series Pre-Rinse Kit
- 12" Wall Bracket
- 1/4 Turn Ceramic Cartridges
- Integral Check Valves
- Color Coded Hot & Cold Indicators
- 1/2" Female Inlets
- Industrial Comfort Grip
- Pivot Pro™
- Industrial Hose

Part Number	LIST PRICE
BKF-IMSPR-WB-G	\$820

BKF-IMSPR-WB-G

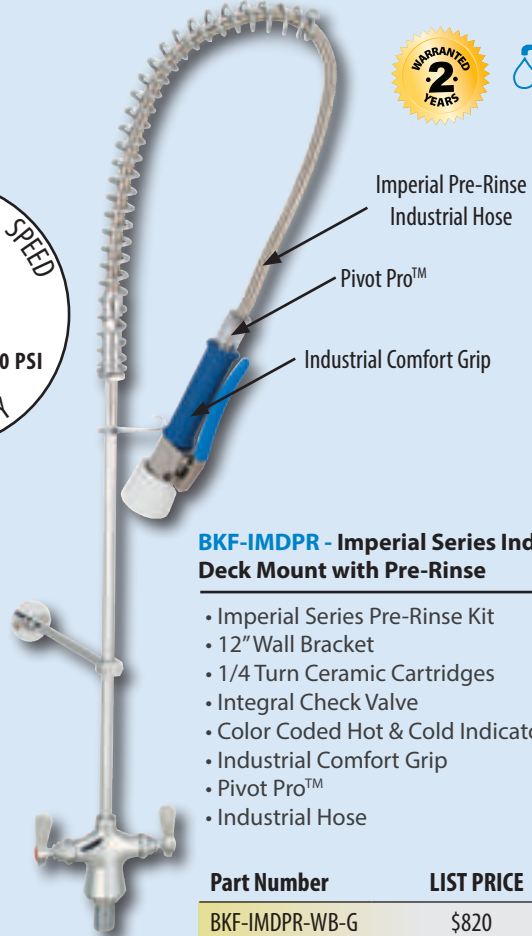

### BKF-IMDPR - Imperial Series Industrial Deck Mount with Pre-Rinse

- Imperial Series Pre-Rinse Kit
- 12" Wall Bracket
- 1/4 Turn Ceramic Cartridges
- Integral Check Valve
- Color Coded Hot & Cold Indicators
- Industrial Comfort Grip
- Pivot Pro™
- Industrial Hose

Part Number	LIST PRICE
BKF-IMDPR-WB-G	\$820

BKF-IMDPR-WB-G

## Why Does the Industrial Imperial Style Stand Out from the Rest?

- Industrial Comfort Grip
- Pivot Pro™
- Imperial Pre-Rinse Industrial Hose



Industrial Comfort Grip

Pivot Pro™

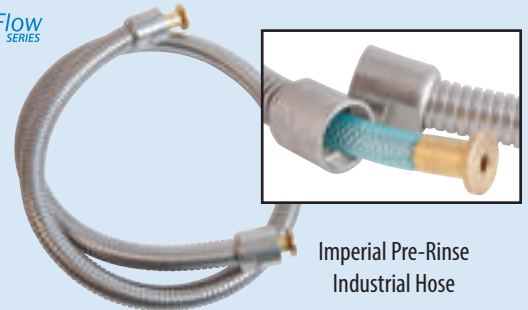

Imperial Pre-Rinse Industrial Hose

\* Accessories are interchangeable with other BK Faucet / Pre-Rinse Products.



*Imperial* Series

# COMMERCIAL

**Interested in a More Economical Imperial Pre-Rinse Faucet?**  
Check out our NEW Line of Imperial Faucets!

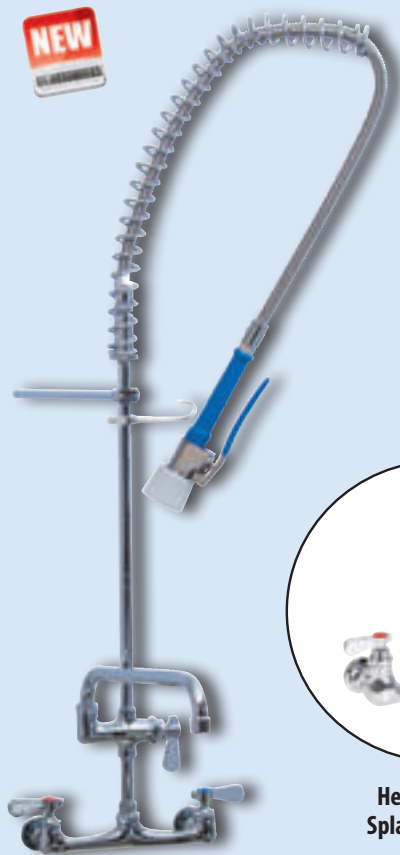

BKF-CSPR-WB-AF12-G



**Heavy Duty  
Splash Mount**



BKF-CDPR-WB-G

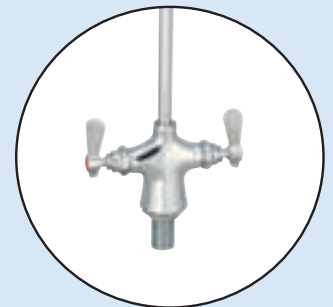

**Deck Mount**

**BKF-CSPR-WB-G - Imperial Series Commercial 8" Heavy Duty Splash Mount with Pre-Rinse**



- Imperial Series Commercial Pre-Rinse Kit
- 12" Wall Bracket
- 1/4 Turn Ceramic Cartridges
- Integral Check Valves
- Color Coded Hot & Cold Indicators
- 1/2" Female Inlets

Part Number	LIST PRICE
BKF-CSPR-WB-G	\$589
BKF-CSPR-WB-AF12-G	\$669



**BKF-CDPR-WB-G - Imperial Series Commercial 8" Deck Mount with Pre-Rinse**



- Imperial Series Commercial Pre-Rinse Kit
- 12" Wall Bracket
- 1/4 Turn Ceramic Cartridges
- Integral Check Valves
- Color Coded Hot & Cold Indicators
- 1/2" Female Inlets

Part Number	LIST PRICE
BKF-CDPR-WB-G	\$589
BKF-CDPR-WB-AF12-G	\$669





# Imperial Series

## STANDARD

**Interested in a More Economical Imperial Pre-Rinse Faucet?**

Check out our NEW Line of Imperial Faucets!



Standard Duty Splash Mount

**BKF-SVSPR-WB-G - Imperial Series Standard 8" Standard Duty Splash Mount with Pre-Rinse**

- Imperial Series Pre-Rinse Kit
- 12" Wall Bracket
- 1/4 Turn Ceramic Cartridges
- Integral Check Valves
- Color Coded Hot & Cold Indicators
- 1/2" Female Inlets



Part Number	LIST PRICE
BKF-SVSPR-WB-G	\$499
BKF-SVSPR-WB-AF12-G	\$579



**Save Water.  
Save Energy.  
Save Money.**

- Water Sense®, An EPA Program



**Every Drop Counts!**

**Replacement Parts  
For Pre-Rinse Faucets**

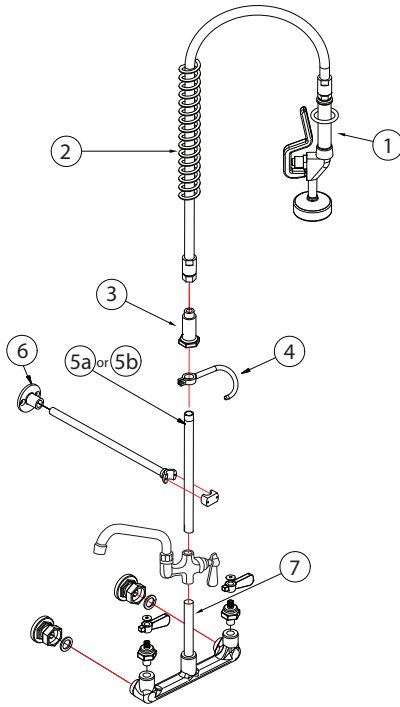

Part Number	LIST PRICE
1 BKH-HANDLE Pre-Rinse Spray Handle	\$17
2 BK-PR-SPRING Pre-Rinse Spring for Spray Hose	\$23
3 BK-PR-SPR Retainer Hose	\$23
4 BK-PR-SHR Retainer Hook	\$23
5a BK-PR-18RP-G 18" Riser Pipe	\$46
5b BK-PR-24RP-G 24" Riser Pipe	\$53
6 BK-PR-WB Wall Bracket	\$42
7 BK-3.5RP-G Add A Faucet Riser Pipe	\$15



**XRK-PRV-G  
Repair Kit for BK-PRV-G**

LIST PRICE  
**\$26.00**

- 2 Face Plates: Standard/Low-Flow
- Valve Pin
- Bumper Ring
- O-Rings (4)
- Washers (2)
- Springs (2)
- Grommets (2)



**Spray Hose**

- Includes Universal Adapter
- Recommended Point of Purchase Item

Part Number	Length	LIST PRICE
BKH-44-G	44"	\$71
BKH-60-G	60"	\$82
BKH-72-G	72"	\$88



**BK-PRV-1-G**  
1.0 GPM Pre-Rinse  
Spray Head



LIST PRICE  
**\$79.00**

- Exceeds Requirements for CUWCC & FEMP



**BK-PRV-G**  
2.2 GPM Pre-Rinse  
Spray Head



LIST PRICE  
**\$57.00**

**60 PSI & Less Than 1 GPM**



**BKF-KC3PRV**  
Imperial Series Kwik  
Clean3® Tri-spray Nozzle



LIST PRICE  
**\$315.00**

- Stainless Steel operating parts
- 5 Year Warranty

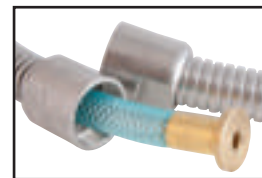

**BKF-IMH**  
Imperial Series Pre-Rinse Hose

LIST PRICE  
**\$210.00**

- Stainless Steel, armor-wrapped outer hose, lightweight inner hose
- 2 Year Warranty



**BKF-IMPVPRO**  
Imperial Series Pivot Pro™  
Swivel Connector

LIST PRICE  
**\$180.00**

- All Stainless Steel

**Lead Free + Work Force Pre-Rinse Faucet**

work**FORCE**  
SERIES



**BKF-VSMPR-G**  
**8" Value Splash Mount**  
**Pre-Rinse**

- Triple-Ply Hose Rated to 300 PSI
- 12" Wall Bracket
- 1/4 Turn Ceramic Cartridges
- Color Coded Hot & Cold Indicators
- 1/2" Female Inlets

Part Number	LIST PRICE
* BKF-LF-VSMPR-WB-G	\$339
BKF-VSMPR-WB-G	\$295
* BKF-VSMPR-WB-AF8-G	\$355
* BKF-VSMPR-WB-AF10-G	\$357
* BKF-VSMPR-WB-AF12-G	\$357
* BKF-VSMPR-WB-AF14-G	\$357

**LEAD FREE**  
ANSI 372 Compliant



Shown as  
BKF-VSMPR-WB-AF12-G

**Did You Know?**

"Compared with a spray valve, using 3.2 gpm, a 1.6 gpm model in a small, quick-serve restaurant will save about 50,000 gallons (190,000 l) of water and \$1,000 in energy costs per year." - *BuildingGreen.com*

pti**Flow**  
SERIES



Shown as  
BKF-SMPR-WB-AF12-G

**BKF-SMPR-WB-G<sup>+</sup>**  
**8" Splash Mount Heavy Duty**  
**Pre-Rinse**

- Triple-Ply Hose Rated to 300 PSI
- 12" Wall Bracket
- 1/4 Turn Ceramic Cartridges
- Integral Check Valves
- Color Coded Hot & Cold Indicators
- 1/2" Female Inlets

Part Number	LIST PRICE
* BKF-LF-SMPR-WB-G	\$410
BKF-SMPR-WB-G	\$338
* BKF-SMPR-WB-AF8-G	\$394
* BKF-SMPR-WB-AF10-G	\$394
* BKF-SMPR-WB-AF12-G	\$394
* BKF-SMPR-WB-AF14-G	\$394

**Did You Know?**

According to the EPA, one way to start a long-term water management plan is by "Increasing the water efficiency of fixtures, equipment, systems, and processes."

pti**Flow**  
SERIES



Shown as  
BKF-DMPR-WB-G

† ASME 112.18.1 / CSA B125.1



H/C Mixing Hoses  
Included

**BKF-DMPR-WB-G<sup>+</sup>**  
**Deck Mount Pre-Rinse**

- Triple-Ply Hose Rated to 300 PSI
- 12" Wall Bracket
- 1/4 Turn Ceramic Cartridges
- Integral Check Valves
- Color Coded Hot & Cold Indicators

Part Number	LIST PRICE
* BKF-LF-DMPR-WB-G	\$410
BKF-DMPR-WB-G	\$338
* BKF-DMPR-WB-AF8-G	\$394
* BKF-DMPR-WB-AF10-G	\$394
* BKF-DMPR-WB-AF12-G	\$394
* BKF-DMPR-WB-AF14-G	\$394

**NOTE: (\*) We have combined NSF Certified components to offer you a greater value. (Example: BKF-SMPR-WB-AF12-G) Though these part numbers are not Certified by NSF, each component that makes up the following part numbers are individually Certified by NSF and are thereby approved for use in your facility. For more information, please call 888-310-4393.**



**BKF-SWMPR-WB-G**  
Single Valve Wall Mount

- Triple-Ply Hose Rated to 300 PSI
- 12" Wall Bracket
- 1/4 Turn Ceramic Cartridge
- Integral Check Valve
- 1/2" Female Inlet

Part Number	LIST PRICE
<b>* BKF-LF-SWMPR-WB-G</b>	\$363
BKF-SWMPR-WB-G	\$338



**BKF-SDMPR-WB-G**  
Single Valve Deck Mount

- Triple-Ply Hose Rated to 300 PSI
- 12" Wall Bracket
- 1/4 Turn Ceramic Cartridges
- Integral Check Valve

Part Number	LIST PRICE
<b>* BKF-LF-SDMPR-WB-G</b>	\$353
BKF-SDMPR-WB-G	\$328



**BKF-BWMPR-WB-G**  
Wall Mount Base - No Valve

- Triple-Ply Hose Rated to 300 PSI
- 12" Wall Bracket
- 1/2" Female Inlet

Part Number	LIST PRICE
<b>* BKF-LF-BWMPR-WB-G</b>	\$341
BKF-BWMPR-WB-G	\$316



**BKF-BDMPR-WB-G**  
Deck Mount Base - No Valve

- Triple-Ply Hose Rated to 300 PSI
- 12" Wall Bracket

Part Number	LIST PRICE
<b>* BKF-LF-BDMPR-WB-G</b>	\$341
BKF-BDMPR-WB-G	\$316



**BKF-8HDDPR-WB-G<sup>†</sup>**  
8" Deck Mount Pre-Rinse

- Triple-Ply Hose Rated to 300 PSI
- 12" Wall Bracket
- 1/4 Turn Ceramic Cartridges
- Integral Check Valves
- Color Coded Hot & Cold Indicators
- 1/2" Female Inlets

Part Number	LIST PRICE
<b>* BKF-LF-8HDDPR-WB-G</b>	\$398
BKF-8HDDPR-WB-G	\$373



**BKF-4HDDPR-WB-G<sup>†</sup>**  
4" Deck Mount Pre-Rinse

- Triple-Ply Hose Rated to 300 PSI
- 12" Wall Bracket
- 1/4 Turn Ceramic Cartridges
- Integral Check Valves
- Color Coded Hot & Cold Indicators
- 1/2" Female Inlets

Part Number	LIST PRICE
<b>* BKF-LF-4HDDPR-WB-G</b>	\$386
BKF-4HDDPR-WB-G	\$361

<sup>†</sup> ASME 112.18.1 / CSA B125.1



**Replacement OptiFlow Hot / Cold Valves**

- Used with OptiFlow Faucets
- Hot & Cold Valves Sold Separately and as a Kit



Part Number	Includes	LIST PRICE
BKF-CV-G	Cold Valve	\$29
BKF-HV-G	Hot Valve	\$29
XRK-BKF-G	Kit Includes Hot & Cold Valve	\$58



**BKF-8W-HV/CV-G First Lead Free 1/4 Turn Compression**

- Used with WorkForce Faucets
- Hot & Cold Valves Sold Separately
- Chrome Plated Base
- Black Washer on Base
- First Lead Free 1/4 Turn Compression



Part Number	Includes	LIST PRICE
BKF-8W-HV-G	Hot Valve	\$24
BKF-8W-CV-G	Cold Valve	\$24



**BKF-8W-HVC/CVC-G Current Lead Free 1/4 Turn Ceramic**

- Used with WorkForce Faucets
- Hot & Cold Valves Sold Separately
- Chrome Plated Base
- Red and Blue Base Washer
- Current Lead Free 1/4 Turn Ceramic



Part Number	Includes	LIST PRICE
BKF-8W-HVC-G	Hot Valve	\$22
BKF-8W-CVC-G	Cold Valve	\$22



**Heavy Duty Handle & Valve Kit**

- Hot & Cold Valve Kits Sold Separately



Part Number	Includes	LIST PRICE
BKF-CV-H-G	Cold Valve with Handle	\$42
BKF-HV-H-G	Hot Valve with Handle	\$42



**BKF-W-HV/CV-G Compression Valve**

- Used with WorkForce Faucets
- Hot & Cold Valves Sold Separately
- Threads on Stem
- Compression Valve



Part Number	Includes	LIST PRICE
BKF-W-HV-G	Hot Valve	\$24
BKF-W-CV-G	Cold Valve	\$24



**BKF-W-HVC/CVC-G Current Ceramic Valve**

- Used with WorkForce Faucets
- Hot & Cold Valves Sold Separately
- Clip On Stem
- Lead Free



Part Number	Includes	LIST PRICE
BKF-W-HVC-G	Hot Valve	\$24
BKF-W-CVC-G	Cold Valve	\$24

**BKKV-010XST Replacement Button Valve**

- Used for BK-PRV-1-G and BK-PRV-G Pre-Rinse Spray Heads
- Also used to replace Knee/Foot Valves

LIST PRICE **\$37.00**



**XRK-PDV-G Knee/Foot Valve Repair Kit**

- Kit Includes:
- Valve Bodies (2)
  - Valve Pins (2)
  - Push Buttons (2)
  - Springs (2)
  - Washers (2)
  - Valve Pins (2)
  - Grommets (2)
  - O-Rings (4)

LIST PRICE **\$44.00**



**Faucet Handle Kits**

- Chrome Plated
- (1) Hot, (1) Cold Handle Per Kit

Part Number	Style	LIST PRICE
BKF-SBH	Standard Wrist Blade	\$23
BKF-WBH	Wrist Blade	\$36
BKF-CH	Cross	\$36
BKF-DBH	Dial Blade	\$17





**BKF-SPT**  
Standard Duty Swing Spout

workFORCE SERIES 

• Chrome Plated • 2.2 GPM Flow Rate 

Part Number	Spout Type	LIST PRICE
BKF-SPT-6-G	6" Swing	\$23
BKF-SPT-8-G	8" Swing	\$25
BKF-SPT-10-G	10" Swing	\$25
BKF-SPT-12-G	12" Swing	\$27
BKF-SPT-14-G	14" Swing	\$29
BKF-SPT-16-G	16" Swing	\$34
BKF-SPT-18-G	18" DJ Swing	\$42



**BKF-HSPT**  
Heavy Duty Swing Spout

OptiFlow SERIES 

• Chrome Plated • 2.2 GPM Flow Rate 

Part Number	Spout Type	LIST PRICE
BKF-HSPT-6-G	6" Swing	\$29
BKF-HSPT-8-G	8" Swing	\$32
BKF-HSPT-10-G	10" Swing	\$34
BKF-HSPT-12-G	12" Swing	\$36
BKF-HSPT-14-G	14" Swing	\$38
BKF-HSPT-16-G	16" Swing	\$40
BKF-HSPT-18-G	18" DJ Swing	\$48

## 18" Double Jointed Swing Spout

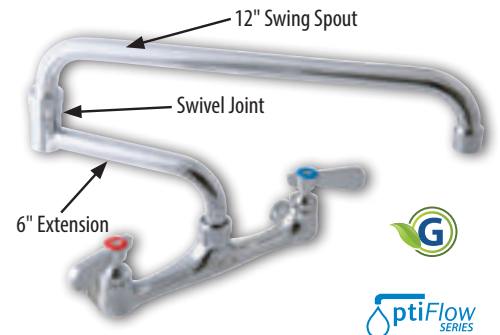

- Maximum Flexibility for Spout Positioning
- Will Fit Any BK Resources Faucet Including Pre-Rinse Units
- Available in WorkForce & OptiFlow
- Lead Free Compliant



**BKF-SPT**  
Standard Duty Gooseneck Spout

workFORCE SERIES 

• Chrome Plated • 2.2 GPM Flow Rate 

Part Number	Spout Type	LIST PRICE
BKF-SPT-3G-G	3" Gooseneck	\$23
BKF-SPT-5G-G	5" Gooseneck	\$27
BKF-SPT-8G-G	8" Gooseneck	\$34



**BKF-HSPT**  
Heavy Duty Gooseneck Spout

OptiFlow SERIES 

• Chrome Plated • 2.2 GPM Flow Rate 

Part Number	Spout Type	LIST PRICE
BKF-HSPT-3G-G	3" Gooseneck	\$29
BKF-HSPT-5G-G	5" Gooseneck	\$36
BKF-HSPT-8G-G	8" Gooseneck	\$40



### BKF-C414-VR Aerator .5 GPM

- Vandal Resistant
- Chrome Plated

**+**   
Add the BKF-C414-VR Aerator to any BK Resources Faucet to make it Low Flow!

See pg. 9 for details

Part Number	LIST PRICE
BKF-C414-VR	\$19



**BKF-AF+**  
Add A Faucet

OptiFlow SERIES 

• 1/4 Turn Ceramic Valve  

• Heavy Duty Spout

Part Number	Spout Size	LIST PRICE
BKF-AF-6-G	6" Swing	\$80
BKF-AF-8-G	8" Swing	\$80
BKF-AF-10-G	10" Swing	\$80
BKF-AF-12-G	12" Swing	\$80
BKF-AF-14-G	14" Swing	\$80
BKF-AF-16-G	16" Swing	\$80
BKF-AF-18-G	18" DJ Swing	\$87



**BKF-8W-ESC**  
Standard Duty Replacement Escutcheon

workFORCE SERIES

• Used for WorkForce Faucets

LIST PRICE **\$23.00**

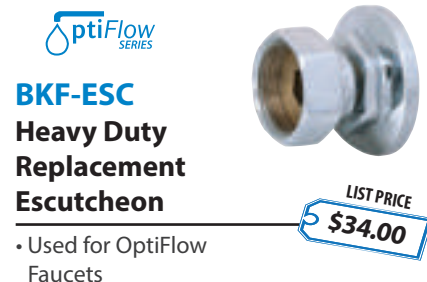

**BKF-ESC**  
Heavy Duty Replacement Escutcheon

OptiFlow SERIES

• Used for OptiFlow Faucets

LIST PRICE **\$34.00**



### Faucet Mounting Hardware

Part Number	Faucet Use	LIST PRICE
BK-DMMK	Deck Mount	\$25
BK-DMMK-90	Splash Mount	\$36

† ASME 112.18.1 / CSA B125.1



Shown  
BK-WS-1SGF-G



**BK-WS-1SGF-G**  
**Glass Filler Water Station**

- Stainless Steel
- O.A Dimensions 13<sup>3/4</sup>" (l) x 10<sup>3/4</sup>" (w) x 1<sup>3/4</sup>" (h)
- Locking Clip For Continuous Flow

Part Number	Details	LIST PRICE
BKF-SGF-G	Faucet Only	\$150
BK-WS	Sink Only	\$81
* BK-WS-1SGF-G	Faucet & Sink Kit	\$218



**BKDC-2124-2H**  
**Point of Sale Work Station**

- T-304 18 ga Stainless Steel
- Hole in top and back to run cords
- Fixed Shelf
- Stainless Steel Legs

LIST PRICE  
**\$875.00**

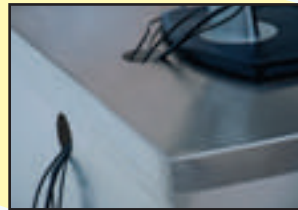

Cords run through holes for less clutter and easier access to outlets



**BKF-SPSF-G**  
**Deck Mount Heavy Duty Single Valve Pantry Faucet**

- 1/4 Turn Ceramic Cartridge
- Chrome Plated

+\$19 List Price  
BKF-C414-VR

Part Number	Description	LIST PRICE
BKF-SPSF-G	Chrome Plated	\$58



**BKF-DWF-G**  
**Dipper Well Faucet**

+\$19 List Price  
BKF-C414-VR

Part Number	Description	LIST PRICE
BKF-DWF-G	Chrome Plated	\$47

**BK-DWBA**  
**Dipperwell Bowl Assembly**

- Basket: 5" (w) x 4<sup>1/2</sup>" (h)
- Bowl: 5<sup>1/2</sup>" (w) x 5<sup>1/2</sup>" (h)



Part Number	Description	LIST PRICE
BK-DWBA	T-304 18 ga. S/S	\$50

**BKSF-WB1**  
**Service Faucet w/ Vacuum Breaker**

- Wall Bracket Included
- Integral Bucket Holder On Spout
- Garden Hose Threading On Spout

+\$19 List Price  
BKF-C414-VR

Part Number	LIST PRICE
BKSF-WB1	\$174

**NOTE: (\*) We have combined NSF Certified components to offer you a greater value. (Example: BK-WS-1SGF-G) Though these part numbers are not Certified by NSF, each component that makes up the following part numbers are individually Certified by NSF and are thereby approved for use in your facility. For more information, please call 888-310-4393.**

# Why workFORCE? SERIES

- Standard Duty has a 1 Year Warranty
- Double O-Ring Spout Seal
- High Polished Nickel Chrome Finish
- Full Replacement Parts Available
- Lead-Free Compliant



**BK Resources has been certified by:**



NSF International to ANSI/ NSF Standard 61 Section 9, Drinking Water System Components – Health Effects. NSF International evaluated both the leaching of contaminants into drinking water from faucets. CSA International - Canada & U.S.



workFORCE  
SERIES



## BKF-8W<sup>†</sup> 8" Splash Mount Standard Duty Faucet

- 1/4 Turn Ceramic Cartridges
- Color Coded Hot & Cold Indicators

 **\$19** List Price  
BKF-C414-VR

Part Number	Spout Type	LIST PRICE
BKF-8W-6-G	6" Swing	\$80
BKF-8W-8-G	8" Swing	\$80
BKF-8W-10-G	10" Swing	\$80
BKF-8W-12-G	12" Swing	\$80
BKF-8W-14-G	14" Swing	\$80
BKF-8W-16-G	16" Swing	\$80
BKF-8W-18-G	18" DJ Swing	\$88
BKF-8W-3G-G	3" Gooseneck	\$80
BKF-8W-5G-G	5" Gooseneck	\$84
BKF-8W-8G-G	8" Gooseneck	\$88
BKF-8W-XX-G	Body Only	\$65

workFORCE  
SERIES



## BK8D<sup>†</sup> 8" Deck Mount Standard Duty Faucet

- 1/4 Turn Ceramic Cartridges
- Color Coded Hot & Cold Indicators

 **\$19** List Price  
BKF-C414-VR

Part Number	Spout Type	LIST PRICE
BK8D-6-G	6" Swing	\$73
BK8D-8-G	8" Swing	\$73
BK8D-10-G	10" Swing	\$73
BK8D-12-G	12" Swing	\$73
BK8D-14-G	14" Swing	\$73
BK8D-16-G	16" Swing	\$73
BK8D-18-G	18" DJ Swing	\$87
BK8D-3G-G	3" Gooseneck	\$73
BK8D-5G-G	5" Gooseneck	\$76
BK8D-8G-G	8" Gooseneck	\$83
BK8D-XX-G	Body Only	\$50

workFORCE  
SERIES



## BKF-W2 4" Splash Mount Shallow Standard Duty Faucet

- 1/4 Turn Ceramic Cartridges
- Color Coded Hot & Cold Indicators
- Wrist Blade Handles Not Available

 **\$19** List Price  
BKF-C414-VR

Part Number	Spout Type	LIST PRICE
BKF-W2-6-G	6" Swing	\$82
BKF-W2-8-G	8" Swing	\$82
BKF-W2-10-G	10" Swing	\$82
BKF-W2-12-G	12" Swing	\$82
BKF-W2-14-G	14" Swing	\$82
BKF-W2-16-G	16" Swing	\$82
BKF-W2-18-G	18" DJ Swing	\$90
BKF-W2-3G-G	3" Gooseneck	\$82
BKF-W2-5G-G	5" Gooseneck	\$86
BKF-W2-8G-G	8" Gooseneck	\$90
BKF-W2-XX-G	Body Only	\$68

workFORCE  
SERIES



## BKF-W<sup>†</sup> 4" Splash Mount Standard Duty Faucet

- 1/4 Turn Ceramic Cartridges
- Color Coded Hot & Cold Indicators
- Wrist Blade Handles Not Available

 **\$19** List Price  
BKF-C414-VR

Part Number	Spout Type	LIST PRICE
BKF-W-6-G	6" Swing	\$63
BKF-W-8-G	8" Swing	\$63
BKF-W-10-G	10" Swing	\$63
BKF-W-12-G	12" Swing	\$63
BKF-W-14-G	14" Swing	\$63
BKF-W-16-G	16" Swing	\$63
BKF-W-18-G	18" DJ Swing	\$71
BKF-W-3G-G	3" Gooseneck	\$63
BKF-W-5G-G	5" Gooseneck	\$67
BKF-W-8G-G	8" Gooseneck	\$71
BKF-W-XX-G	Body Only	\$43

workFORCE  
SERIES



## BKD<sup>†</sup> 4" Deck Mount Standard Duty Faucet

- 1/4 Turn Ceramic Cartridges
- Color Coded Hot & Cold Indicators
- Wrist Blade Handles Not Available

 **\$19** List Price  
BKF-C414-VR

Part Number	Spout Type	LIST PRICE
BKD-6-G	6" Swing	\$61
BKD-8-G	8" Swing	\$61
BKD-10-G	10" Swing	\$61
BKD-12-G	12" Swing	\$61
BKD-14-G	14" Swing	\$61
BKD-16-G	16" Swing	\$61
BKD-18-G	18" DJ Swing	\$69
BKD-3G-G	3" Gooseneck	\$61
BKD-5G-G	5" Gooseneck	\$65
BKD-8G-G	8" Gooseneck	\$69
BKD-XX-G	Body Only	\$45

<sup>†</sup> ASME 112.18.1 / CSA B125.1



# Why OptiFlow?

- Heavy Duty has a 2 Year Warranty
- 1/4 Turn Ceramic Cartridges
- Color Coded Hot & Cold Indicators
- Double O-Ring Spout Seal
- High Polished Nickel Chrome Finish
- Full Replacement Parts Available
- Lead-Free Compliant

**BK Resources has complied with and has been certified by:**

**NSF**  
NSF International to ANSI/ NSF Standard 61 Section 9, Drinking Water System Components – Health Effects. NSF International evaluated both the leaching of contaminants into drinking water from faucets.

**CSA**  
CSA International - Canada & U.S.

† ASME 112.18.1 / CSA B125.1



## BKF<sup>†</sup> 8" Splash Mount Heavy Duty Faucet

- 1/4 Turn Ceramic Cartridges
- Integral Check Valve
- Color Coded Hot & Cold Indicators

**+**   
\$19 List Price  
BKF-C414-VR

Part Number	Spout Type	LIST PRICE
BKF-6-G	6" Swing	\$169
BKF-8-G	8" Swing	\$169
BKF-10-G	10" Swing	\$169
BKF-12-G	12" Swing	\$175
BKF-14-G	14" Swing	\$175
BKF-16-G	16" Swing	\$175
BKF-18-G	18"DJ Swing	\$177
BKF-3G-G	3" Gooseneck	\$169
BKF-5G-G	5" Gooseneck	\$182
BKF-8G-G	8" Gooseneck	\$182
BKF-XX-G	Body Only	\$150



## BKF8HD<sup>†</sup> 8" Deck Mount Heavy Duty Faucet

- 1/4 Turn Ceramic Cartridges
- Integral Check Valve
- Color Coded Hot & Cold Indicators

**+**   
\$19 List Price  
BKF-C414-VR

Part Number	Spout Type	LIST PRICE
BKF8HD-6-G	6" Swing	\$163
BKF8HD-8-G	8" Swing	\$163
BKF8HD-10-G	10" Swing	\$163
BKF8HD-12-G	12" Swing	\$163
BKF8HD-14-G	14" Swing	\$163
BKF8HD-16-G	16" Swing	\$163
BKF8HD-18-G	18"DJ Swing	\$170
BKF8HD-3G-G	3" Gooseneck	\$163
BKF8HD-5G-G	5" Gooseneck	\$167
BKF8HD-8G-G	8" Gooseneck	\$170
BKF8HD-XX-G	Body Only	\$145



## BKF-8DM<sup>†</sup> 8" Deck Mount Heavy Duty Solid Body Faucet

- 1/4 Turn Ceramic Cartridges
- Integral Check Valve
- Color Coded Hot & Cold Indicators

**+**   
\$19 List Price  
BKF-C414-VR

Part Number	Spout Type	LIST PRICE
BKF-8DM-6-G	6" Swing	\$167
BKF-8DM-8-G	8" Swing	\$167
BKF-8DM-10-G	10" Swing	\$167
BKF-8DM-12-G	12" Swing	\$167
BKF-8DM-14-G	14" Swing	\$167
BKF-8DM-16-G	16" Swing	\$167
BKF-8DM-18-G	18"DJ Swing	\$175
BKF-8DM-3G-G	3" Gooseneck	\$167
BKF-8DM-5G-G	5" Gooseneck	\$170
BKF-8DM-8G-G	8" Gooseneck	\$175
BKF-8DM-XX-G	Body Only	\$142



## BKF-8SM 8" Splash Mount Heavy Duty Faucet

- 1/4 Turn Ceramic Cartridges
- Integral Check Valve
- Color Coded Hot & Cold Indicators

**+**   
\$19 List Price  
BKF-C414-VR

Part Number	Spout Type	LIST PRICE
BKF-8SM-6-G	6" Swing	\$197
BKF-8SM-8-G	8" Swing	\$197
BKF-8SM-10-G	10" Swing	\$197
BKF-8SM-12-G	12" Swing	\$197
BKF-8SM-14-G	14" Swing	\$197
BKF-8SM-16-G	16" Swing	\$197
BKF-8SM-18-G	18"DJ Swing	\$208
BKF-8SM-3G-G	3" Gooseneck	\$197
BKF-8SM-5G-G	5" Gooseneck	\$204
BKF-8SM-8G-G	8" Gooseneck	\$208
BKF-8SM-XX-G	Body Only	\$175



**BKF-4DM<sup>†</sup>**  
**4" Deck Mount**  
**Solid Body Faucet**



**+**   
**\$19** List Price  
BKF-C414-VR

- 1/4 Turn Ceramic Cartridges
- Integral Check Valves
- Color Coded Hot & Cold Indicators

Part Number	Spout Type	LIST PRICE
BKF-4DM-6-G	6" Swing	\$132
BKF-4DM-8-G	8" Swing	\$132
BKF-4DM-10-G	10" Swing	\$132
BKF-4DM-12-G	12" Swing	\$132
BKF-4DM-14-G	14" Swing	\$132
BKF-4DM-16-G	16" Swing	\$132
BKF-4DM-18-G	18" DJ Swing	\$143
BKF-4DM-3G-G	3" Gooseneck	\$132
BKF-4DM-5G-G	5" Gooseneck	\$139
BKF-4DM-8G-G	8" Gooseneck	\$142
BKF-4DM-XX-G	Body Only	\$118



**BKF4HD<sup>†</sup>**  
**4" Deck Mount**  
**Heavy Duty Faucet**



**+**   
**\$19** List Price  
BKF-C414-VR

- 1/4 Turn Ceramic Cartridges
- Integral Check Valves
- Color Coded Hot & Cold Indicators

Part Number	Spout Type	LIST PRICE
BKF4HD-6-G	6" Swing	\$152
BKF4HD-8-G	8" Swing	\$152
BKF4HD-10-G	10" Swing	\$152
BKF4HD-12-G	12" Swing	\$152
BKF4HD-14-G	14" Swing	\$152
BKF4HD-16-G	16" Swing	\$152
BKF4HD-18-G	18" DJ Swing	\$163
BKF4HD-3G-G	3" Gooseneck	\$152
BKF4HD-5G-G	5" Gooseneck	\$159
BKF4HD-8G-G	8" Gooseneck	\$163
BKF4HD-XX-G	Body Only	\$130



**BKF-4SM<sup>†</sup>**  
**4" Splash Mount Heavy**  
**Duty Solid Body Faucet**



**+**   
**\$19** List Price  
BKF-C414-VR

- 1/4 Turn Ceramic Cartridges
- Integral Check Valve
- Color Coded Hot & Cold Indicators

Part Number	Spout Type	LIST PRICE
BKF-4SM-6-G	6" Swing	\$145
BKF-4SM-8-G	8" Swing	\$145
BKF-4SM-10-G	10" Swing	\$145
BKF-4SM-12-G	12" Swing	\$145
BKF-4SM-14-G	14" Swing	\$145
BKF-4SM-16-G	16" Swing	\$145
BKF-4SM-18-G	18" DJ Swing	\$152
BKF-4SM-3G-G	3" Gooseneck	\$145
BKF-4SM-5G-G	5" Gooseneck	\$149
BKF-4SM-8G-G	8" Gooseneck	\$152
BKF-4SM-XX-G	Body Only	\$115

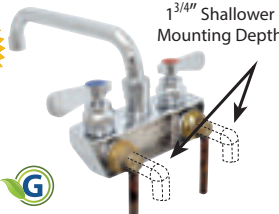

**BKF-4SM2**  
**4" Splash Mount**  
**Shallow Solid Body Faucet**



**+**   
**\$19** List Price  
BKF-C414-VR

- 1/4 Turn Ceramic Cartridges
- Integral Check Valves
- Color Coded Hot & Cold Indicators

Part Number	Spout Type	LIST PRICE
BKF-4SM2-6-G	6" Swing	\$163
BKF-4SM2-8-G	8" Swing	\$163
BKF-4SM2-10-G	10" Swing	\$163
BKF-4SM2-12-G	12" Swing	\$163
BKF-4SM2-14-G	14" Swing	\$163
BKF-4SM2-16-G	16" Swing	\$163
BKF-4SM2-18-G	18" DJ Swing	\$170
BKF-4SM2-3G-G	3" Gooseneck	\$163
BKF-4SM2-5G-G	5" Gooseneck	\$167
BKF-4SM2-8G-G	8" Gooseneck	\$170
BKF-4SM2-XX-G	Body Only	\$125

**OptiFlow**  
**Valve Diagram**

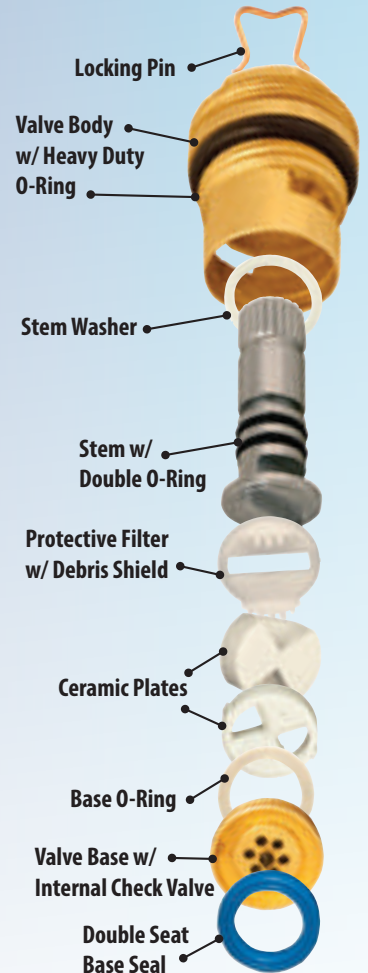

<sup>†</sup> ASME 112.18.1 / CSA B125.1



**BKF-WPF+**  
**Deck Mount Standard Duty Single Valve Pantry Faucet**

- 1/4 Turn Ceramic Cartridge
- Interchangeable Spouts
- Chrome Plated

+ **\$19** List Price  
BKF-C414-VR

Part Number	Spout Type	LIST PRICE
BKF-WPF-6-G	6" Swing	\$82
BKF-WPF-8-G	8" Swing	\$82
BKF-WPF-10-G	10" Swing	\$82
BKF-WPF-12-G	12" Swing	\$82
BKF-WPF-14-G	14" Swing	\$82
BKF-WPF-16-G	16" Swing	\$82
BKF-WPF-18-G	18" DJ Swing	\$90
BKF-WPF-3G-G	3" Gooseneck	\$82
BKF-WPF-5G-G	5" Gooseneck	\$86
BKF-WPF-8G-G	8" Gooseneck	\$90



**BKF-DPF+**  
**Deck Mount Dual Valve Pantry Faucet**

- 1/4 Turn Ceramic Cartridges
- Interchangeable Spouts
- Chrome Plated
- Integral Check Valve

+ **\$19** List Price  
BKF-C414-VR

Part Number	Spout Type	LIST PRICE
BKF-DPF-6-G	6" Swing	\$174
BKF-DPF-8-G	8" Swing	\$174
BKF-DPF-10-G	10" Swing	\$174
BKF-DPF-12-G	12" Swing	\$174
BKF-DPF-14-G	14" Swing	\$174
BKF-DPF-16-G	16" Swing	\$174
BKF-DPF-18-G	18" DJ Swing	\$183
BKF-DPF-3G-G	3" Gooseneck	\$174
BKF-DPF-5G-G	5" Gooseneck	\$179
BKF-DPF-8G-G	8" Gooseneck	\$183



**BKF-SPF+**  
**Deck Mount Heavy Duty Single Valve Pantry Faucet**

- 1/4 Turn Ceramic Cartridge
- Interchangeable Spouts
- Chrome Plated
- Integral Check Valve

+ **\$19** List Price  
BKF-C414-VR

Part Number	Spout Type	LIST PRICE
BKF-SPF-6-G	6" Swing	\$116
BKF-SPF-8-G	8" Swing	\$116
BKF-SPF-10-G	10" Swing	\$116
BKF-SPF-12-G	12" Swing	\$116
BKF-SPF-14-G	14" Swing	\$116
BKF-SPF-16-G	16" Swing	\$116
BKF-SPF-18-G	18" DJ Swing	\$126
BKF-SPF-3G-G	3" Gooseneck	\$116
BKF-SPF-5G-G	5" Gooseneck	\$122
BKF-SPF-8G-G	8" Gooseneck	\$126



+ **\$19** List Price  
BKF-C414-VR

**BKF-DHR-G**  
**Deck Mount Dual Valve Hi-Rise Pantry Faucet**

- 1/4 Turn Ceramic Cartridges
- Interchangeable Spouts
- Chrome Plated
- Integral Check Valve

LIST PRICE **\$279.00**



+ **\$19** List Price  
BKF-C414-VR

**BKF-SHR-G**  
**Deck Mount Single Valve Hi-Rise Pantry Faucet**

- 1/4 Turn Ceramic Cartridge
- Interchangeable Spouts
- Chrome Plated
- Integral Check Valve

LIST PRICE **\$187.00**



+ **\$19** List Price  
BKF-C414-VR

**BKF-8HR-G**  
**8" Deck Mount Heavy Duty Hi-Rise Pantry Faucet**

- 1/4 Turn Ceramic Cartridges
- Interchangeable Spouts
- Chrome Plated
- Integral Check Valve

LIST PRICE **\$256.00**



+ **\$19** List Price  
BKF-C414-VR

**BKF-4HR-G**  
**4" Deck Mount Heavy Duty Hi-Rise Pantry Faucet**

- 1/4 Turn Ceramic Cartridges
- Interchangeable Spouts
- Chrome Plated
- Integral Check Valve

LIST PRICE **\$267.00**

† ASME 112.18.1 / CSA B125.1

**BKKVSGS<sup>†</sup>**  
**Dual Pedal**  
**Knee Valve Kit**



SHOWN AS:  
BKKVSGS-G

- Includes BKF-WMB 3 1/2" Gooseneck Spout
- Chrome Plated Pedals
- Knee Valve Bracket Required for Hand Sinks

  
\$19 List Price  
BKF-C414-VR

Part Number	Spout Mounting	LIST PRICE
BKKV-G	N/A	\$158
BKKV-DGS-G	Deck	\$197
BKKVSGS-G	Splash	\$197

**BKSPKVSGS<sup>†</sup>**  
**Single Pedal**  
**Knee Valve Kit**



2-Hole Base

SHOWN AS:  
BKSPKVSGS-G

- Cast Body
- Chrome Plated Pedals
- Knee Valve Bracket Required for Hand Sinks

  
\$19 List Price  
BKF-C414-VR

Part Number	Spout Mounting	LIST PRICE
BKSPKV-G	N/A	\$88
BKSPKV-DGS-G	Deck	\$128
BKSPKVSGS-G	Splash	\$128

**BKFVSGS<sup>†</sup>**  
**Dual Pedal**  
**Foot Valve Kit**



SHOWN AS:  
BKFVSGS-G

- Cast Body
- Ideal For Floor Mount Application
- Chrome Plated Pedals

  
\$19 List Price  
BKF-C414-VR

Part Number	Spout Mounting	LIST PRICE
BKFV-G	N/A	\$134
BKFVSGS-G	Splash	\$174
BKFV-DGS-G	Deck	\$174

**BKSPFV-SGS<sup>†</sup>**  
**Single Pedal**  
**Foot Valve Kit**



2-Hole Base

SHOWN AS:  
BKSPFV-SGS-G

- Cast Body
- Ideal for Floor Mount Application
- Chrome Plated

  
\$19 List Price  
BKF-C414-VR

Part Number	Spout Mounting	LIST PRICE
BKSPFV-G	N/A	\$101
BKSPFV-SGS-G	Splash	\$139
BKSPFV-DGS-G	Deck	\$139

**BKF-WMB<sup>†</sup> - Splash Mount Spout Base**

- 1/2" NPS Threading
- Chrome Plated
- Swivel Spout

  
\$19 List Price  
BKF-C414-VR



Part Number	Spout Type	LIST PRICE
BKF-WMB-6-G	6" Swing	\$69
BKF-WMB-8-G	8" Swing	\$69
BKF-WMB-10-G	10" Swing	\$69
BKF-WMB-12-G	12" Swing	\$69
BKF-WMB-14-G	14" Swing	\$69
BKF-WMB-16-G	16" Swing	\$69
BKF-WMB-18-G	18" DJ Swing	\$80
BKF-WMB-3G-G	3" Gooseneck	\$69
BKF-WMB-5G-G	5" Gooseneck	\$74
BKF-WMB-8G-G	8" Gooseneck	\$80

**BKF-DMB<sup>†</sup> - Deck Mount Spout Base**

- 1/2" NPS Threading
- Chrome Plated
- Swivel Spout

  
\$19 List Price  
BKF-C414-VR



Part Number	Spout Type	LIST PRICE
BKF-DMB-6-G	6" Swing	\$69
BKF-DMB-8-G	8" Swing	\$69
BKF-DMB-10-G	10" Swing	\$69
BKF-DMB-12-G	12" Swing	\$69
BKF-DMB-14-G	14" Swing	\$69
BKF-DMB-16-G	16" Swing	\$69
BKF-DMB-18-G	18" DJ Swing	\$80
BKF-DMB-3G-G	3" Gooseneck	\$69
BKF-DMB-5G-G	5" Gooseneck	\$74
BKF-DMB-8G-G	8" Gooseneck	\$80

<sup>†</sup> ASME 112.18.1 / CSA B125.1



**BKF-4DMUS-G**  
4" O.C. Deck  
Mount Utility Spray

LIST PRICE  
**\$349.00**

- Integral Check Valves
- Wall Hook Included
- Vacuum Breaker To Prevent Back Flow
- 72" Stainless Steel Braided Hose Included
- 1/4 Turn Ceramic Cartridges



**BKF-8DMUS-G**  
8" O.C. Deck  
Mount Utility Spray

LIST PRICE  
**\$372.00**

- Integral Check Valves
- Wall Hook Included
- Vacuum Breaker To Prevent Back Flow
- 72" Stainless Steel Braided Hose Included
- 1/4 Turn Ceramic Cartridges



**BKF-DDMUS-G**  
Dual Valve  
Deck Mount Utility Spray

H/C Mixing Hoses Included

LIST PRICE  
**\$349.00**

- Integral Check Valves
- Wall Hook Included
- Vacuum Breaker To Prevent Back Flow
- 72" Stainless Steel Braided Hose Included
- 1/4 Turn Ceramic Cartridges



**BKF-SDMUS-G**  
Single Valve  
Deck Mount Utility Spray

LIST PRICE  
**\$279.00**

- Integral Check Valve
- Wall Hook Included
- Vacuum Breaker To Prevent Back Flow
- 72" Stainless Steel Braided Hose Included
- 1/4 Turn Ceramic Cartridge



**BKF-BDMUS-G**  
Remote Valve  
Deck Mount Utility Spray

LIST PRICE  
**\$279.00**

- Wall Hook Included
- Vacuum Breaker To Prevent Back Flow
- 72" Stainless Steel Braided Hose Included



**BKF-8SMUS-G**  
8" O.C. Wall  
Mount Utility Spray

LIST PRICE  
**\$349.00**

- Integral Check Valves
- Wall Hook Included
- Vacuum Breaker To Prevent Back Flow
- 72" Stainless Steel Braided Hose Included
- 1/4 Turn Ceramic Cartridges



**BKF-BSMUS-G**  
Remote Valve  
Wall Mount Utility Spray

LIST PRICE  
**\$279.00**

- Wall Hook Included
- Vacuum Breaker To Prevent Back Flow
- 72" Stainless Steel Braided Hose Included



**BKF-SSMUS-G**  
Single Valve  
Wall Mount Utility Spray

LIST PRICE  
**\$279.00**

- Integral Check Valve
- Wall Hook Included
- Vacuum Breaker To Prevent Back Flow
- 72" Stainless Steel Braided Hose Included
- 1/4 Turn Ceramic Cartridges



**Faucet Mounting Hardware**

90° Elbow  
Not Included  
In BK-DMMK

Part Number	Faucet Use	LIST PRICE
BK-DMMK	Deck Mount	\$25
BK-DMMK-90	Splash Mount	\$36





**BKF-4DMPF-G**  
4" O.C. Deck  
Mount Pot Filler

LIST PRICE  
**\$349.00**

- Integral Check Valves
- Wall Hook Included
- Vacuum Breaker To Prevent Back Flow
- 72" Stainless Steel Braided Hose Included
- 1/4 Turn Ceramic Cartridges



**BKF-8DMPF-G**  
8" O.C. Deck  
Mount Pot Filler

LIST PRICE  
**\$372.00**

- Integral Check Valves
- Wall Hook Included
- Vacuum Breaker To Prevent Back Flow
- 72" Stainless Steel Braided Hose Included
- 1/4 Turn Ceramic Cartridges



**BKF-DDMPF-G**  
Dual Valve  
Deck Mount Pot Filler

H/C Mixing Hoses Included

LIST PRICE  
**\$349.00**

- Integral Check Valves
- Wall Hook Included
- Vacuum Breaker To Prevent Back Flow
- 72" Stainless Steel Braided Hose Included
- 1/4 Turn Ceramic Cartridges



**BKF-SDMPF-G**  
Single Valve  
Deck Mount Pot Filler

LIST PRICE  
**\$279.00**

- Integral Check Valve
- Wall Hook Included
- Vacuum Breaker To Prevent Back Flow
- 72" Stainless Steel Braided Hose Included
- 1/4 Turn Ceramic Cartridges



**BKF-BDMPF-G**  
Remote Valve  
Deck Mount Pot Filler

LIST PRICE  
**\$279.00**

- Wall Hook Included
- Vacuum Breaker To Prevent Back Flow
- 72" Stainless Steel Braided Hose Included



**BKF-8SMPF-G**  
8" O.C. Wall  
Mount Pot Filler







LIST PRICE  
**\$349.00**

- Integral Check Valves
- Wall Hook Included
- Vacuum Breaker To Prevent Back Flow
- 72" Stainless Steel Braided Hose Included
- 1/4 Turn Ceramic Cartridges



**BKH**  
Stainless Steel Spray Hose

- Includes Universal Adapter
- Recommended POP item
- Rated To 300 PSI

Part Number	NSF	Green G	LIST PRICE
BKH-44-G			\$71
BKH-60-G			\$82
BKH-72-G			\$88



**BKF-BSMPF-G**  
Remote Valve  
Wall Mount Pot Filler

LIST PRICE  
**\$279.00**

- Wall Hook Included
- Vacuum Breaker To Prevent Back Flow
- 72" Stainless Steel Braided Hose Included



**BKF-SSMPF-G**  
Single Valve  
Wall Mount Pot Filler

LIST PRICE  
**\$279.00**

- Integral Check Valve
- Wall Hook Included
- Vacuum Breaker To Prevent Back Flow
- 72" Stainless Steel Braided Hose Included
- 1/4 Turn Ceramic Cartridges

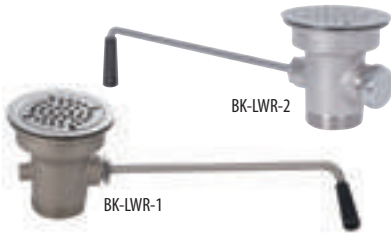

**BK-LWR - Twist Drain**

- Dual Functioning Outlet Features 2" Male & 1 1/2" Female Threading
- S/S Strainer
- Fits 3 1/2" Openings

Part #	Material	Overflow Cap	LIST PRICE
BK-LWR-1	Brass	N/A	\$63
BK-LWR-2		✓	\$48
BK-LWR-3	Brass	✓	\$99

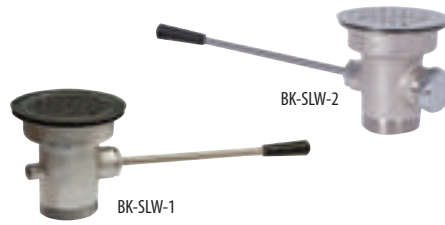

**BK-SLW - Straight Drain**

- Dual Functioning Outlet Features 2" Male & 1 1/2" Female Threading
- S/S Strainer
- Fits 3 1/2" Openings

Part #	Material	Overflow Cap	LIST PRICE
BK-SLW-1	Brass	N/A	\$63
BK-SLW-2		✓	\$48
BK-SLW-3	Brass	✓	\$99

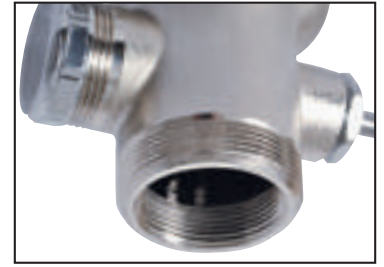

**ALL Lever Drains Have Dual Threaded Design**

**Overflow Cap Included On Models:**

- BK-LWR-2
- BK-LWR-3
- BK-SLW-2
- BK-SLW-3



**BK-LWR Twist Drain with Overflow**

- Dual Functioning Outlet Features 2" Male & 1 1/2" Female Threading
- S/S Strainer
- Fits 3 1/2" Openings

Part #	Material	LIST PRICE
BK-LWR-10	Brass	\$105
BK-LWR-20		\$90



**BK-SLW Straight Drain with Overflow**

- Dual Functioning Outlet Features 2" Male & 1 1/2" Female Threading
- S/S Strainer
- Fits 3 1/2" Openings

Part #	Material	LIST PRICE
BK-SLW-10	Brass	\$105
BK-SLW-20		\$90



**BK-6LW-O Twist Drain with Overflow**

- Dual Functioning Outlet Features 2" Male & 1 1/2" Female Threading
- Fits 3 1/2" Openings

LIST PRICE  
**\$66.00**

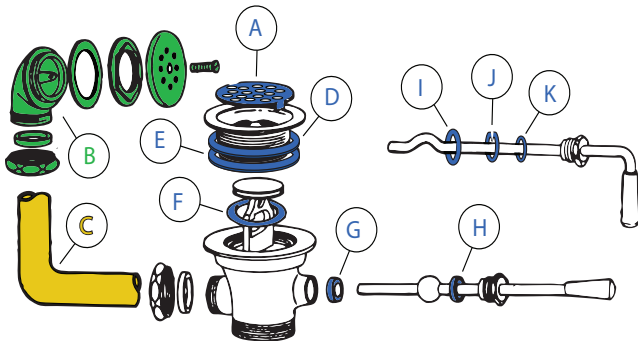

**Lever Drain Replacement Parts**

Part #	Description	LIST PRICE
A	LDR-SS-35 3 1/2" Strainer	\$2
B	005032 Overflow Head	\$34
C	005031 Overflow Tube	\$42

**XRK-LDR Lever Drain Repair Kit (Includes)**



LIST PRICE  
**\$27.00**

Part #	Description	Qty. Included in Kit
D	LDR-PD-35 3 1/2" Paper Gasket	1
E	LDR-RG-35 3 1/2" Rubber Gasket	1
F	BK-LW-OR Plunger Seal	1
G	BK-LDP-HW1 Packing Nut Bushing	1
H	BK-LDP-HW2 Handle Seal	1
I	BK-LDP-HW3 Washer	1
J	BK-LDR-EC Retaining Clip	1
K	BK-LDP-HW4 O-Ring	1



**BKDR-4**  
3 1/2" SS  
Basket Drain

- Crumb Cup Included
- 1 1/2" Outlet Connection

Part #	Description	LIST PRICE
BKDR-4		\$6
BKDR-4-304	T-304 S/S	\$8



**BKDR-2**  
1 7/8" SS  
Basket Drain

- Crumb Cup Included
- 1 1/2" Outlet Connection

LIST PRICE  
**\$4.00**



+   
Add the BKF-C414-VR  
Aerator to any  
BK Resources Faucet to  
make it Low Flow!

See pg. 9 for details



**BKF-C414-VR - Aerator .5 GPM**

- Vandal Resistant
- Chrome Plated

Part #	LIST PRICE
BKF-C414-VR	\$19



**BK-DC-35**  
Crumb Cup

- Fits BKDR-4 Basket Drain

LIST PRICE  
**\$6.00**



**BKDR-HD4**  
Heavy Duty  
Brass Drain

- Ideal for Mop Sink
- 3 1/2" Opening

LIST PRICE  
**\$59.00**



**BK-PTTP**  
CPB P-Trap  
with Tail Piece

- Chrome Plated
- Washers included

LIST PRICE  
**\$25.00**



**BK-OT**  
Overflow  
Tube

- Fits 2" Drain

Part #	Size	LIST PRICE
BK-OT-15075	7"	\$11
BK-OT-15105	10"	\$13



**BKDR - Drain Plugs**

- Available in Brass or Chrome
- See Below For Sizes

Part #	Flange	Drain	Length	Finish	LIST PRICE
BKDR-15BR	1 7/8"	1"	1 1/2"	Brass	\$11
BKDR-15CP	1 7/8"	1"	1 1/2"	Chrome	\$11
BKDR-305BR	1 1/8"	5/8"	2"	Brass	\$8
BKDR-305CP	1 1/8"	5/8"	2"	Chrome	\$8
BKDR-325BR	2"	1"	3 1/4"	Brass	\$15
BKDR-325CP	2"	1"	3 1/4"	Chrome	\$17
BKDR-335BR	3"	1 1/2"	1 1/2"	Brass	\$21
BKDR-335CP	3"	1 1/2"	1 1/2"	Chrome	\$23
BKDR-33BR	3"	1 1/2"	3"	Brass	\$25
BKDR-33CP	3"	1 1/2"	3"	Chrome	\$25



**BK-DAC**  
Floor Drain  
Assembly Cover



**BK-DAB**  
Floor Drain Bowl



**BK-DAS**  
Floor Drain Strainer

**Floor Drain Assembly**

Part #	Description	Overall Dimensions	LIST PRICE
BK-DAC	Floor Drain Assembly Cover	6 1/4"	\$25
BK-DAB	Floor Drain Bowl	6 1/2"(w) X 3 1/4"(h)	\$42
BK-DAS	Floor Drain Strainer	6 1/4"(w) X 2 1/8"(h)	\$42
BK-TBDA	Floor Drain Bowl Kit Includes: (1)BK-DAC, (1)BK-DAB, (1)BK-DAS		\$84



**Soap Dispenser**

- Capacity of 600 ml (20 fl. oz.)

Part Number	Description	LIST PRICE
BK-SD	Soap Disp.	\$23

BKS - Three Compartment Sinks



- 18 ga T-304 Stainless Steel
- 1 5/8" Galvanized Legs w/ 1" Adjustable High Impact Corrosion Resistant Feet
- 1/4" Pitched Drainboards To Ensure Proper Drainage
- 1 1/2" Rounded Front and Side Edges
- Accommodates 8" On Center Faucets
- 3 (BKDR-4) 3 1/2" Drains Included
- 9" Backsplash

Additional Accessories

- Lever Drains Pg. 27
- Faucets Pg. 20-21

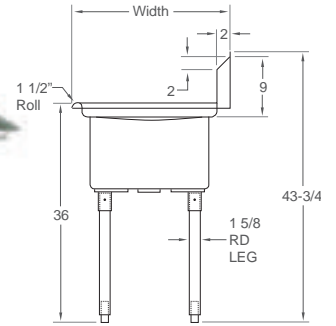

PROFILE DRAWING

NEW SIZE AVAILABLE:  
BKS-3-18-12-24T

Part Number	Bowl Size (l x w x d)	Unit Size (l x w)	Drainboard	Sets of Faucet Holes	LIST PRICE	VOLUME LIST PRICING* (Min. of 5. Any Combo.)
BKS-3-15-14	15" x 15" x 14"	50" x 20 <sup>13/16"</sup>	None	1	\$886	\$797
BKS-3-15-14-15L	15" x 15" x 14"	62 <sup>1/2"</sup> x 20 <sup>13/16"</sup>	(1) L - 15"	1	\$944	\$851
BKS-3-15-14-15R	15" x 15" x 14"	62 <sup>1/2"</sup> x 20 <sup>13/16"</sup>	(1) R - 15"	1	\$944	\$851
BKS-3-15-14-15T	15" x 15" x 14"	75" x 20 <sup>13/16"</sup>	(2) - 15"	1	\$1,003	\$903
BKS-3-1620-12	16" x 20" x 12"	53" x 25 <sup>13/16"</sup>	None	1	\$1,003	\$903
BKS-3-1620-12-18L	16" x 20" x 12"	68 <sup>1/2"</sup> x 25 <sup>13/16"</sup>	(1) L - 18"	1	\$1,084	\$976
BKS-3-1620-12-18R	16" x 20" x 12"	68 <sup>1/2"</sup> x 25 <sup>13/16"</sup>	(1) R - 18"	1	\$1,084	\$976
BKS-3-1620-12-18T	16" x 20" x 12"	84" x 25 <sup>13/16"</sup>	(2) - 18"	1	\$1,107	\$996
BKS-3-1620-14-18T	16" x 20" x 14"	84" x 25 <sup>13/16"</sup>	(2) - 18"	1	\$1,186	\$1,067
BKS-3-18-12	18" x 18" x 12"	59" x 23 <sup>13/16"</sup>	None	1	\$1,003	\$903
BKS-3-18-12-18L	18" x 18" x 12"	74 <sup>1/2"</sup> x 23 <sup>13/16"</sup>	(1) L - 18"	1	\$1,084	\$976
BKS-3-18-12-18R	18" x 18" x 12"	74 <sup>1/2"</sup> x 23 <sup>13/16"</sup>	(1) R - 18"	1	\$1,084	\$976
BKS-3-18-12-18T	18" x 18" x 12"	90" x 23 <sup>13/16"</sup>	(2) - 18"	1	\$1,107	\$996
BKS-3-18-12-24T	18" x 18" x 12"	102" x 23 <sup>13/16"</sup>	(2) - 24"	1	\$1,199	\$1,080
BKS-3-18-14-18T	18" x 18" x 14"	90" x 23 <sup>13/16"</sup>	(2) - 18"	1	\$1,186	\$1,067
BKS-3-1824-14-24L	18" x 24" x 14"	80 <sup>1/2"</sup> x 29 <sup>13/16"</sup>	(1) L - 24"	1	\$1,325	\$1,192
BKS-3-1824-14-24R	18" x 24" x 14"	80 <sup>1/2"</sup> x 29 <sup>13/16"</sup>	(1) R - 24"	1	\$1,325	\$1,192
BKS-3-1824-14-24T	18" x 24" x 14"	102" x 29 <sup>13/16"</sup>	(2) - 24"	1	\$1,429	\$1,285
BKS-3-1824-14-18T	18" x 24" x 14"	90" x 29 <sup>13/16"</sup>	(2) - 18"	1	\$1,325	\$1,192
BKS-3-24-14	24" x 24" x 14"	77" x 29 <sup>13/16"</sup>	None	2	\$1,452	\$1,306
BKS-3-20-12-18T	20" x 20" x 12"	96" x 25 <sup>13/16"</sup>	(2) - 18"	1	\$1,198	\$1,077
BKS-3-20-14-24T	20" x 20" x 14"	108" x 25 <sup>13/16"</sup>	(2) - 24"	1	\$1,290	\$1,162
BKS-3-2030-12-20T	20" x 30" x 12"	100" x 35 <sup>13/16"</sup>	(2) - 20"	1	\$1,429	\$1,285
BKS-3-2030-14-24T	20" x 30" x 14"	108" x 35 <sup>13/16"</sup>	(2) - 24"	1	\$1,556	\$1,399
BKS-3-24-14-24L	24" x 24" x 14"	98 <sup>1/2"</sup> x 29 <sup>13/16"</sup>	(1) L - 24"	2	\$1,566	\$1,410
BKS-3-24-14-24R	24" x 24" x 14"	98 <sup>1/2"</sup> x 29 <sup>13/16"</sup>	(1) R - 24"	2	\$1,566	\$1,410
BKS-3-24-14-24T	24" x 24" x 14"	120" x 29 <sup>13/16"</sup>	(2) - 24"	2	\$1,693	\$1,525

\* Volume Pricing is based on Minimum Purchase of 5 (any combo). Pricing is per sink.

## Two Compartment Sinks - S/S Legs & Bracing

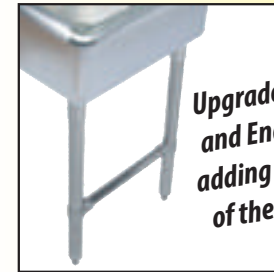
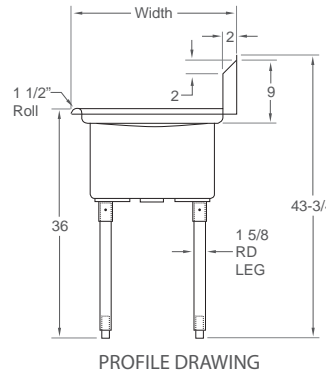

Upgrade To S/S Legs and End Bracing by adding "5" to the end of the Part Number

LIST PRICE  
**\$122**

**EXAMPLE:**

BKS-1-1620-12S = BKS-1-1620-12 + BKL-SSH-1220

⚠ See below for Details.

### BKS - Two Compartment Sinks

- 18 ga T-304 Stainless Steel
- 1<sup>5/8</sup>" Galvanized Legs w/ 1" Adjustable High Impact Corrosion Resistant Feet
- 1/4" Pitched Drainboards To Ensure Proper Drainage

- 1 1/2" Rounded Front and Side Edges
- Accommodates 8" On Center Faucets
- 2 (BKDR-4) 3 1/2" Drains Included
- 9" Backsplash



Part Number	Bowl Size (l x w x d)	Unit Size (l x w)	Drainboard	Sets of Faucet Holes	LIST PRICE	VOLUME LIST PRICING*
						(Min. of 5. Any Combo.)
BKS-2-1620-12	16" x 20" x 12"	37" x 25 <sup>13/16"</sup>	None	1	\$736	\$664
BKS-2-1620-12-18L	16" x 20" x 12"	52 1/2" x 25 <sup>13/16"</sup>	(1) L - 18"	1	\$840	\$757
BKS-2-1620-12-18R	16" x 20" x 12"	52 1/2" x 25 <sup>13/16"</sup>	(1) R - 18"	1	\$840	\$757
BKS-2-1620-12-18T	16" x 20" x 12"	68" x 25 <sup>13/16"</sup>	(2) - 18"	1	\$899	\$809
BKS-2-18-12	18" x 18" x 12"	41" x 23 <sup>13/16"</sup>	None	1	\$736	\$664
BKS-2-18-12-18L	18" x 18" x 12"	56 1/2" x 23 <sup>13/16"</sup>	(1) L - 18"	1	\$840	\$757
BKS-2-18-12-18R	18" x 18" x 12"	56 1/2" x 23 <sup>13/16"</sup>	(1) R - 18"	1	\$840	\$757
BKS-2-18-12-18T	18" x 18" x 12"	72" x 23 <sup>13/16"</sup>	(2) - 18"	1	\$899	\$809
BKS-2-20-12-18T	20" x 20" x 12"	76" x 25 <sup>13/16"</sup>	(2) - 18"	1	\$921	\$830
BKS-2-24-14	24" x 24" x 14"	53" x 29 <sup>13/16"</sup>	None	1	\$1,084	\$976
BKS-2-24-14-24L	24" x 24" x 14"	74 1/2" x 29 <sup>13/16"</sup>	(1) L - 24"	1	\$1,244	\$1,119
BKS-2-24-14-24R	24" x 24" x 14"	74 1/2" x 29 <sup>13/16"</sup>	(1) R - 24"	1	\$1,244	\$1,119
BKS-2-24-14-24T	24" x 24" x 14"	96" x 29 <sup>13/16"</sup>	(2) - 24"	1	\$1,371	\$1,224

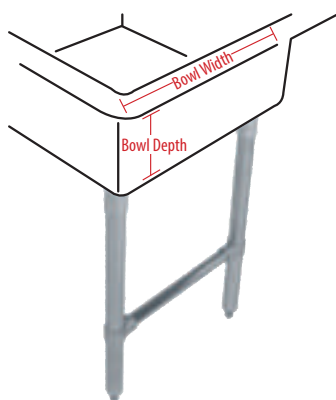

### BKS - S/S Legs and End Bracing

- 18 ga T-304 Stainless Steel
  - 1<sup>5/8</sup>" Legs w/ 1" Adjustable High Impact Corrosion Resistant Feet
  - Add-on to any NSF Certified Compartment Sink
  - Includes 4 legs-2pcs bracing, 4 pcs BKBS-1 Sockets & 4 pcs BK-SSPAF
- \* Recommended use with BK Resources Sinks ONLY

**EXAMPLE:**

If you have a BKS-1-1620-12 (Bowl Width 20" and Bowl Depth 12") you will need Part Number BKL-SSH-1220

Part Number	Fits: Bowl Depth	Fits: Bowl Width	LIST PRICE	Part Number	Fits: Bowl Depth	Fits: Bowl Width	LIST PRICE
BKL-SSH-1014	10"	14"	\$122	BKL-SSH-1424	14"	24"	\$122
BKL-SSH-1218	12"	18"	\$122	BKL-SSH-1418	14"	18"	\$122
BKL-SSH-1220	12"	20"	\$122	BKL-SSH-1415	14"	15"	\$122
BKL-SSH-1216	12"	16"	\$122	BKL-SSH-1420	14"	20"	\$122
BKL-SSH-1230	12"	30"	\$122	BKL-SSH-1430	14"	30"	\$122

\* Volume Pricing is based on Minimum Purchase of 5 (any combo). Pricing is per sink.



**BKCS**

**18 ga. T-304 S/S Three Compartment Corner Sinks**

- Accommodates (2) 8" O.C. Faucets
- 1 1/2" Rounded Front & Side Edges
- 1 5/8" Galvanized Legs w/Adjustable High Impact Corrosion Resistant Feet
- 3 1/2" Drains Included
- 9" Backsplash
- 43 1/2" Overall Height
- 33 3/4" Work Height
- T-304 18 ga. S/S Deck & Bowls
- Cross Bracing



Part Number	Unit Size (l x w)	Bowl Dim. (l x w x d)	Drainboard (l x w)	LIST PRICE	VOLUME LIST PRICING* (Min. of 5. Any Combo.)
BKCS-3-18-14-18T	57" x 57"	18" x 18" x 14"	18" x 23 1/2"	\$1,439	\$1,296
BKCS-3-18-14-24T	63" x 63"	18" x 18" x 14"	24" x 23 1/2"	\$1,664	\$1,498
BKCS-3-24-14-24T	75" x 75"	24" x 24" x 14"	24" x 29 1/2"	\$2,188	\$1,970



Upgrade To S/S Legs and End Bracing by adding "S" to the end of the Part Number

LIST PRICE \$122

**EXAMPLE:**  
BKS-1-1620-12S = BKS-1-1620-12 + BKL-SSH-1220  
See Pg. 30 for Details.

- Additional Accessories**
- Lever Drains Pg. 27
  - Faucets Pg. 20-21

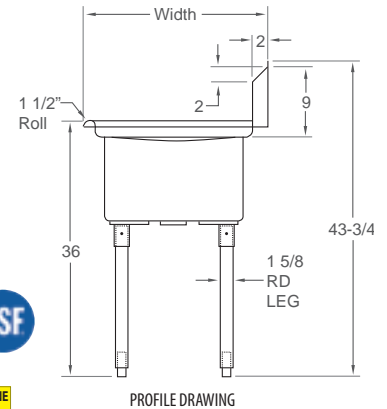

**BKS - One Compartment Sinks**

- 18 ga T-304 Stainless Steel
- 1 5/8" Galvanized Legs w/ 1" Adjustable High Impact Corrosion Resistant Feet
- 1/4" Pitched Drainboards To Ensure Proper Drainage
- 1 1/2" Rounded Front and Side Edges
- Accommodates 8" On Center Faucets
- 1 (BKDR-4) 3 1/2" Drain Included
- 9" Backsplash

Part Number	Bowl Size (l x w x d)	Unit Size (l x w)	Drainboard	LIST PRICE	VOLUME LIST PRICING* (Min. of 5. Any Combo.)
BKS-1-1620-12	16" x 20" x 12"	21" x 25 13/16"	None	\$381	\$343
BKS-1-1620-12-18L	16" x 20" x 12"	36 1/2" x 25 13/16"	(1) L - 18"	\$518	\$466
BKS-1-1620-12-18R	16" x 20" x 12"	36 1/2" x 25 13/16"	(1) R - 18"	\$518	\$466
BKS-1-1620-12-18T	16" x 20" x 12"	52" x 25 13/16"	(2) - 18"	\$657	\$591
BKS-1-18-12	18" x 18" x 12"	23" x 23 13/16"	None	\$381	\$343
BKS-1-18-12-18L	18" x 18" x 12"	38 1/2" x 23 13/16"	(1) L - 18"	\$518	\$466
BKS-1-18-12-18R	18" x 18" x 12"	38 1/2" x 23 13/16"	(1) R - 18"	\$518	\$466
BKS-1-18-12-18T	18" x 18" x 12"	54" x 23 13/16"	(2) - 18"	\$657	\$591
BKS-1-1824-14	18" x 24" x 14"	23" x 29 13/16"	None	\$508	\$458
BKS-1-1824-14-24L	18" x 24" x 14"	44 1/2" x 29 13/16"	(1) L - 24"	\$622	\$560
BKS-1-1824-14-24R	18" x 24" x 14"	44 1/2" x 29 13/16"	(1) R - 24"	\$622	\$560
BKS-1-1824-14-24T	18" x 24" x 14"	66" x 29 13/16"	(2) - 24"	\$749	\$674
BKS-1-20-12	20" x 20" x 12"	25" x 25 13/16"	None	\$472	\$425
BKS-1-24-14	24" x 24" x 14"	29" x 29 13/16"	None	\$599	\$539
BKS-1-24-14-24L	24" x 24" x 14"	50 1/2" x 29 13/16"	(1) L - 24"	\$899	\$809
BKS-1-24-14-24R	24" x 24" x 14"	50 1/2" x 29 13/16"	(1) R - 24"	\$899	\$809
BKS-1-24-14-24T	24" x 24" x 14"	72" x 29 13/16"	(2) - 24"	\$1,071	\$965

\* Volume Pricing is based on Minimum Purchase of 5 (any combo). Pricing is per sink.

## Three & Four Compartment Sinks- Convenience Store Sinks

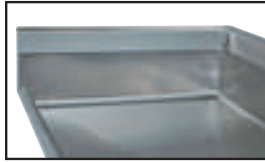

Left Side Back-Splash



Lever Drain Bracket



### Additional Accessories

- Lever Drains Pg. 27
- Faucets Pg. 20-21

### BKS-3-1824-14-24TL Three Compartment Sink with Left Side Back Splash

- For corner applications
- Drains Included

Part Number	Bowl Size (l x w x d)	Unit Size (l x w)	Sets of Faucet Holes	Drainboard	LIST PRICE	VOLUME LIST PRICING* (Min. of 5. Any Combo.)
BKS-3-1824-14-24TL	18" x 24" x 14"	102" x 29 <sup>13/16"</sup>	1	(2) - 24"	\$1,429	\$1,285



### BKS-4-1620-14-18T Four Compartment Sink



- 18 ga T-304 Stainless Steel Deck & Bowls
- Accommodates (2) 8" O.C. Faucets
- 1 5/8" Galvanized Legs w/ Adjustable High Impact Corrosion Resistant Feet
- 43<sup>9/16"</sup> Overall Height
- 33<sup>3/4"</sup> Work Height
- 18" Drainboards
- 3<sup>1/2"</sup> Drains Included
- 9<sup>3/4"</sup> Backsplash

Part Number	Unit Size (l x w)	Bowl Dim. (l x w x d)	LIST PRICE	VOLUME LIST PRICING* (Min. of 5. Any Combo.)
BKS-4-1620-14-18T	100" x 25 <sup>3/16"</sup>	16" x 20" x 14"	\$1,416	\$1,275



**Add a Prep Basket**  
⚠ See Pg. 91 for more options.

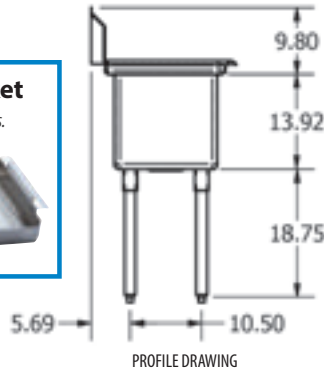

Faucets Sold Separately



Faucets Sold Separately

### BKS - Convenience Store Sinks

- 18 ga T-304 Stainless Steel Deck & Bowls
- 1/4" Pitched Drainboards To Ensure Proper Drainage
- Smaller Size for Small Spaces
- 3<sup>1/2"</sup> Drains Included
- Accommodates 8" O.C. Faucets
- 1<sup>1/2"</sup> Rounded Front and Side Edges
- 9" Backsplash
- 1<sup>5/8"</sup> Galvanized Legs w/ Adjustable High Impact Corrosion Resistant Feet



Part Number	Bowl Dim. (l x w x d)	Unit Size (l x w)	Drainboard Size	# of Sinks	Sets of Faucet Holes	LIST PRICE	VOLUME LIST PRICING* (Min. of 5. Any Combo.)
BKS-3-1014-10	10" x 14" x 10"	35 <sup>1/2"</sup> x 19 <sup>13/16"</sup>	NA	3	1	\$749	\$674
BKS-3-1014-10-15L	10" x 14" x 10"	47 <sup>1/2"</sup> x 19 <sup>13/16"</sup>	Left 15"	3	1	\$770	\$693
BKS-3-1014-10-15R	10" x 14" x 10"	47 <sup>1/2"</sup> x 19 <sup>13/16"</sup>	Right 15"	3	1	\$770	\$693
BKS-3-1014-10-15T	10" x 14" x 10"	60" x 19 <sup>13/16"</sup>	(2) - 15"	3	1	\$772	\$695
BKS-3-1220-12-12T	12" x 20" x 12"	60" x 25 <sup>13/16"</sup>	(2) - 12"	3	1	\$828	\$745
BKS-3-1416-12-12T	14" x 16" x 12"	66" x 21 <sup>13/16"</sup>	(2) - 12"	3	1	\$863	\$777

\* Volume Pricing is based on Minimum Purchase of 5 (any combo). Pricing is per sink.



Faucets Sold Separately



Faucets Sold Separately

Faucets Sold Separately



BK8BS-3-18-12





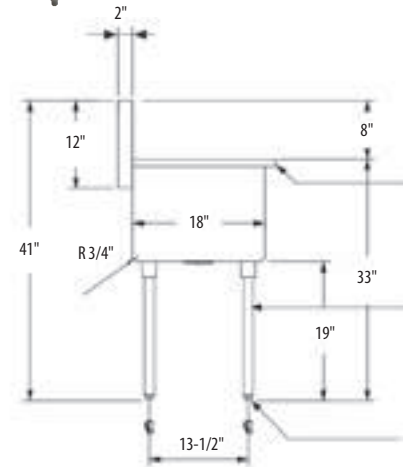



**Additional Accessories**

- Lever Drains Pg. 27
- Faucets Pg. 20-21



**BK8BS - Budget Sinks**

- 18 ga. Stainless Steel Deck & Bowls
- 1 1/2" Rounded Front and Side Edges
- 1 5/8" Galvanized Legs w/ Adjustable High Impact Corrosion Resistant Feet
- 3 1/2" Drains Included
- Accommodates 8" O.C. Splashmount Faucets
- Square Corners
- Not NSF Approved

Part #	LIST PRICE	Bowl Dim. (l x w x d)	Unit Size (l x w)	#of Sinks	Sets of Faucet Holes
BK8BS-1-18-14	\$302	18" x 18" x 14"	21" x 21 1/2"	1	1
BK8BS-1-1821-14	\$358	18" x 21" x 14"	21" x 24 1/2"	1	1
BK8BS-1-24-14	\$399	24" x 24" x 14"	27" x 27 1/2"	1	1 
BK8BS-2-18-12	\$518	18" x 18" x 12"	39" x 21 1/2"	2	1 
BK8BS-2-1821-12	\$557	18" x 21" x 12"	39" x 24 1/2"	2	1 
BK8BS-2-24-12	\$691	24" x 24" x 12"	51" x 27 1/2"	2	1 
BK8BS-3-1221-12	\$651	12" x 21" x 12"	39" x 24 1/2"	3	1 
BK8BS-3-18-12	\$701	18" x 18" x 12"	57" x 21 1/2"	3	1 
BK8BS-3-1821-12	\$853	18" x 21" x 12"	57" x 24 1/2"	3	1 
BK8BS-3-24-12	\$967	24" x 24" x 12"	75" x 27 1/2"	3	2 

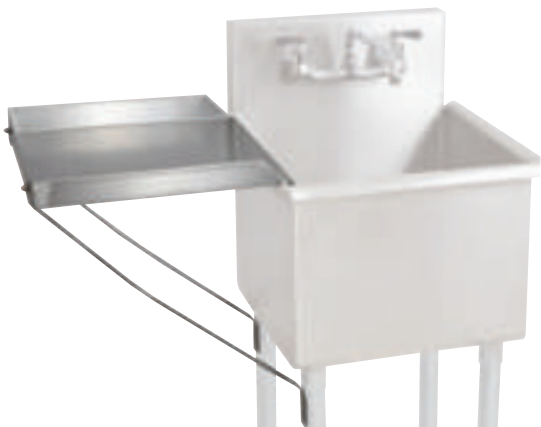

**BK8BS-DD - Detachable Drainboards**

- 18 ga T-430 Stainless Steel
- Designed For Use On BK8BS Budget Sinks
- Easy To Attach & Detach
- Self-Tapping Screws Included
- Not NSF Listed

T-430 Part #	Size	LIST PRICE
BK8BS-DD18	18" x 18"	\$133
BK8BS-DD1821	18" x 21"	\$146
BK8BS-DD24	24" x 24"	\$156



### BKMS - Stainless Steel Mop Sinks

- T-304 18 ga. Stainless Steel
- Skirted on 3 Sides
- Floor Mounted
- Includes: BKDR-HD4 Brass Drain



(Shown as BKMS-1620-12)

Part Number	Description	LIST PRICE
BKMS-1620-6	Mop Sink - 6" Depth	\$437
BKMS-1620-12	Mop Sink - 12" Depth	\$437

### BKMS - Stainless Steel Mop Sink Kits

- MOP SINK KITS INCLUDE:**
- T-304 18 ga. Stainless Steel
  - 6" or 12" Deep Mop Sink
  - BKDR-HD4 Brass Drain
  - BK-SFH-48 48" Service Hose
  - BKSF-WB1 Service Faucet
  - BK-UTH-5 Utility Tool Holder
  - Skirted on 3 Sides
  - Floor Mounted

Part Number	Description	LIST PRICE
BKMS-1620-6-KIT	Mop Sink Kit - 6" Depth	\$645
BKMS-1620-12-KIT	Mop Sink Kit - 12" Depth	\$645



(Shown as BKMS-1620-12-KIT)  
(Mops Not Included)

### BK-SFH-48 48" Service Faucet Hose



- Standard Garden Hose Threading

LIST PRICE  
**\$25.00**

### BK-UTH-5 5 Slot Utility Tool Holder



- 5 Utility Slots & 6 Plastic Hooks

LIST PRICE  
**\$25.00**



### BKSF-WB1 Service Faucet w/ Vacuum Breaker



- Wall Bracket Included
- Integral Bucket Holder On Spout
- Garden Hose Threading On Spout
- Built-In Check Valves to Prevent Back Flow

LIST PRICE  
**\$174.00**



### BKSF-WB2 Service Faucet w/ Vacuum Breaker



- Wall Bracket Included
- Integral Bucket Holder On Spout
- Garden Hose Threading On Spout

LIST PRICE  
**\$145.00**

### BKS-1-SK-20-8-ME - Soak Sink Marine Edge

- 16 ga T-304 Stainless Steel
- 20" Work Height
- Bowl Size: 20" x 20" x 8"d
- O.D.- 27 1/2" x 27 1/2" x 21 3/4" h
- 5" Polyurethane Casters w/ Top Lock Brake
- Twist Drain Included
- S/S Gussets, Legs & Cross Bracing
- Corner Bumpers

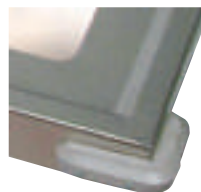

LIST PRICE  
**\$600.00**



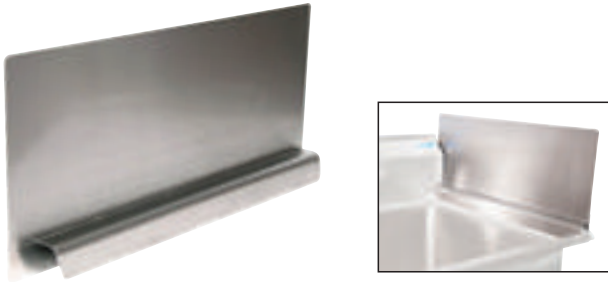

**BKS-RES - Reversible End Splash**

- 18 ga T-304 Stainless Steel
- Fits Left or Right Side of Sink

Part #	Fits Bowl Width	LIST PRICE
BKS-RES-18	18"	\$57
BKS-RES-20	20"	\$62
BKS-RES-24	24"	\$73

**Single Removable Side Splash For Wall Mount Hand Sink**

- 16 ga. 304 Stainless Steel
- Mounts to Wall & Sink
- Hardware Included
- Caulking Included

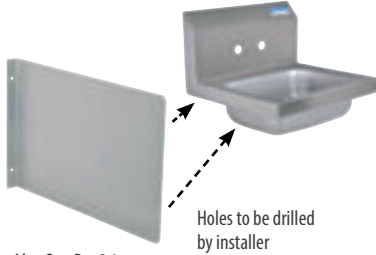

**14x10 - Handsink**

**BKHS-SSW1410** ⚠️ Also See Pg. 36

**Single Removable Side Splash for Splash Mount Hand Sinks**

- Fits BK Resources 10" x 14" Hand Sink (BKHS-W-1410)
- Guard is 15 1/2" x 9 1/2"

LIST PRICE  
**\$47.00**

**BKHS-SSD1410** ⚠️ Also See Pg. 36

**Single Removable Side Splash for Deck Mount Hand Sinks**

- Fits BK Resources 10" x 14" Hand Sink (BKHS-W-1410)
- Guard is 17" x 9 1/2"

LIST PRICE  
**\$47.00**

**9x9 - Handsink**

**BKHS-SWSS** ⚠️ Also See Pg. 37

**Single Removable Side Splash for Splash Mount Space Saver Hand Sinks**

- Fits BK Resources 9" X 9" Space Saver Hand Sinks (BKHS-W-SS)
- Guard is 14 1/2" x 9 1/2"

LIST PRICE  
**\$47.00**

**BKHS-DWSS** ⚠️ Also See Pg. 37

**Single Removable Side Splash for Deck Mount Space Saver Hand Sinks**

- Fits BK Resources 9" X 9" Space Saver Hand Sinks (BKHS-D-SS)
- Guard is 16" x 9 1/2"

LIST PRICE  
**\$47.00**



**BK-FSS**

**Universal Deep Fryer Splash Shield**

LIST PRICE  
**\$85.00**

- 18 ga. Stainless Steel
- Fits Left or Right Side of Fryer



Sink Sold Separately

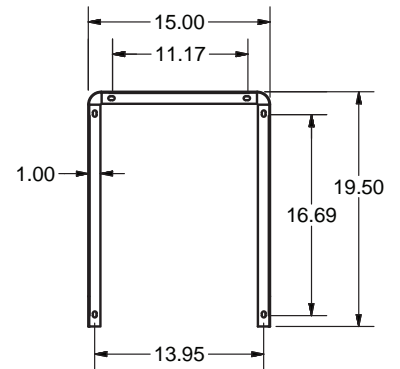

**BK-DI1014-SS**

**3-Sided Removable Side Splash for 10" x 14" Drop In Sinks**

- 16 ga. 304 Stainless Steel
- Fits ALL BK Resources 10" x 14" Drop In Sinks

LIST PRICE  
**\$110.00**

⚠️ Also See Pg. 39

**BKUB-SS18**

**Single Removable Side Splash for 18" Underbar Equipment**

- 16 ga. 304 Stainless Steel
- Fits BK Resources 18" Slim Line Underbar Equipment

⚠️ Also See Pg. 56

LIST PRICE  
**\$31.00**

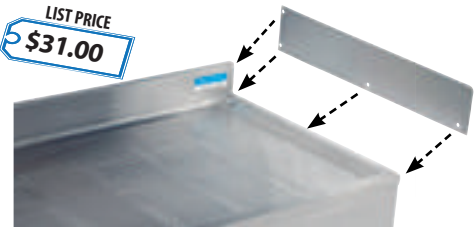

**BKUB-SS21**

**Single Removable Side Splash for 21" Underbar Equipment**

- 16 ga. 304 Stainless Steel
- Fits BK Resources 21" Standard Underbar Equipment

⚠️ Also See Pg. 54

LIST PRICE  
**\$32.00**

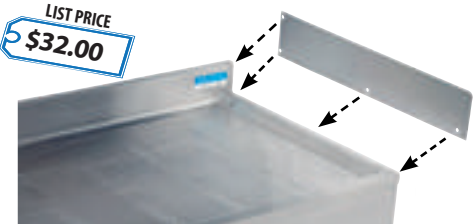



**Hand Sink Packages Now Include LEAD FREE Plumbing, ANSI 372 Compliant**



BKHS-W-1410-P-G



BKHS-D-1410-P-G

**Single Removable Side Splash for 14 X10 Hand Sinks**

to be used with BKHS-W-1410 and BKHS-D-1410

⚠️ Also See Pg. 35

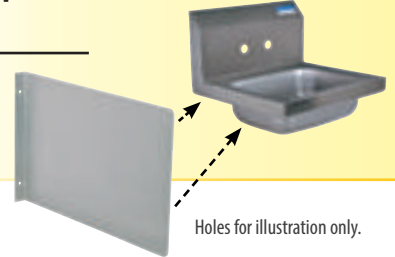

Holes for illustration only.



BKHS-W-1410-4D-TD includes Towel & Soap Dispenser



**BK-SD Soap Dispenser**

LIST PRICE  
**\$23.00**

to be used with BKHS-W-1410-4D-TD, BKHS-W-1410-4D-TD-P-G & BKHS-W-1410-1-4D-TD

⚠️ Also See Pg. 28



BKHS-W-1410-SS-P-G



BKHS-D-1410-SS-P-G

**14" x 10" T-304 Stainless Steel Hand Sink with Lead Free Faucet**



- Bowl Size: 14" x 10" x 5"
- Mounting Bracket Included
- Drain Included
- Deck Mount Hand Sink Packages Contain Faucet BKD-3G-G
- Splash Mount Hand Sink Packages Contain Faucet BKF-W-3G-G

Sink Only Part Number	Sink Only LIST PRICE	Faucet & Sink Part Number	Faucet & Sink LIST PRICE	Faucet / Spout Mounting	Side Splash	Towel Disp.	Drain Size	Overall Dimensions
BKHS-W-1410	\$142	BKHS-W-1410-P-G	\$203	4" O.C. Splash	-	-	1 7/8"	17" (w) x 15 1/2" (d)
BKHS-W-1410-4D	\$142	BKHS-W-1410-4D-P-G	\$203	4" O.C. Splash	-	-	3 1/2"	17" (w) x 15 1/2" (d)
BKHS-W-1410-4D-TD	\$364	BKHS-W-1410-4D-TD-P-G	\$425	4" O.C. Splash	-	Yes	3 1/2"	17" (w) x 15 1/2" (d)
BKHS-W-1410-SS	\$224	BKHS-W-1410-SS-P-G	\$285	4" O.C. Splash	Dual	-	1 7/8"	17" (w) x 15 1/2" (d)
BKHS-W-1410-RS	\$182	BKHS-W-1410-RS-P-G	\$243	4" O.C. Splash	Right	-	1 7/8"	17" (w) x 15 1/2" (d)
BKHS-W-1410-LS	\$182	BKHS-W-1410-LS-P-G	\$243	4" O.C. Splash	Left	-	1 7/8"	17" (w) x 15 1/2" (d)
BKHS-W-1410-1	\$142	N/A	-	1 Hole Splash	-	-	1 7/8"	17" (w) x 15 1/2" (d)
BKHS-W-1410-1-4D	\$142	N/A	-	1 Hole Splash	-	-	3 1/2"	17" (w) x 15 1/2" (d)
BKHS-W-1410-1-4D-TD	\$354	N/A	-	1 Hole Splash	-	Yes	3 1/2"	17" (w) x 15 1/2" (d)
BKHS-W-1410-1-SS	\$212	N/A	-	1 Hole Splash	Dual	-	1 7/8"	17" (w) x 15 1/2" (d)
BKHS-D-1410	\$142	BKHS-D-1410-P-G	\$203	4" O.C. Deck	-	-	1 7/8"	17" (w) x 17" (d)
BKHS-D-1410-SS	\$224	BKHS-D-1410-SS-P-G	\$285	4" O.C. Deck	Dual	-	1 7/8"	17" (w) x 17" (d)
BKHS-D-1410-1	\$142	N/A	-	1 Hole Deck	-	-	1 7/8"	17" (w) x 17" (d)



BKHS-D-SS-SKTS-P-G  
9"x9" Bowl



BKHS-D-1410-SKTS-P-G  
14"x10" Bowl



**BK-SD**  
**Soap Dispenser**

! Also See Pg. 28

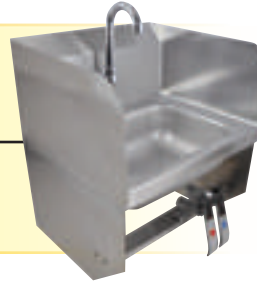

BKHS-W-1410-1-SS-BKK-P-G



BKHS-W-1410-1-BKK-P-G

**14" x 10" T-304 Stainless Steel Hand Sink - Knee Valve Package with Lead Free Faucet**

- Bowl Size: 14" x 10" x 5"
- Mounting Bracket Included
- Drain Included
- 1-7/8" Drain Size
- Deck Mount Hand Sink Packages Contain Faucet BKKV-DGS-G
- Splash Mount Hand Sink Packages Contain Faucet BKKVSGS-G



**Deck Mount Hand Sink w/ Integrated Towel Dispenser**

- 18 ga. T-304
- Mounting Bracket Included
- Includes: BKDR-2 Basket Drain



Sink Only Part Number	Sink Only LIST PRICE	Faucet & Sink Part Number	Faucet & Sink LIST PRICE	Faucet / Spout Mounting	Side Splash	Overall Dimensions
BKHS-D-1410-1-BKK	\$318	BKHS-D-1410-1-BKK-P-G	\$515	Deck	-	17"(w) x 17"(d)
BKHS-D-1410-1-SS-BKK	\$380	BKHS-D-1410-1-SS-BKK-P-G	\$577	Deck	Dual	17"(w) x 17"(d)
BKHS-W-1410-1-BKK	\$318	BKHS-W-1410-1-BKK-P-G	\$515	Splash	-	17"(w) x 15 1/2"(d)
BKHS-W-1410-1-SS-BKK	\$380	BKHS-W-1410-1-SS-BKK-P-G	\$577	Splash	Dual	17"(w) x 15 1/2"(d)

Part Number	Faucet	LIST PRICE
BKHS-D-SS-SKTS	N/A	\$538
BKHS-D-SS-SKTS-P-G	BKD-3G-G	\$599
BKHS-D-1410-SKTS	N/A	\$538
BKHS-D-1410-SKTS-P-G	BKD-3G-G	\$599



BKHS-D-SS-SS-P-G



BKHS-W-SS-P-G



BKHS-W-SS-SS-TD-P-G

**9" x 9" T-304 Stainless Steel Space Saver Hand Sink with Lead Free Faucet**

- Bowl Size: 9" x 9" x 5"
- Drain Included
- 1-7/8" Drain Size
- Deck Mount Hand Sink Packages Contain Faucet BKD-3G-G
- Splash Mount Hand Sink Packages Contain Faucet BKF-W-3G-G



Sink Only Part Number	Sink Only LIST PRICE	Faucet & Sink Part Number	Faucet & Sink LIST PRICE	Faucet / Spout Mounting	Side Splash	Towel & Soap Disp.	Overall Dimensions
BKHS-W-SS	\$142	BKHS-W-SS-P-G	\$203	4" O.C. Splash	-	-	12" (w) x 14 1/2" (d)
BKHS-W-SS-SS-TD	\$498	BKHS-W-SS-SS-TD-P-G	\$559	4" O.C. Splash	Dual	Yes	12" (w) x 16" (d)
BKHS-W-SS-SS	\$224	BKHS-W-SS-SS-P-G	\$285	4" O.C. Splash	Dual	-	12" (w) x 14 1/2" (d)
BKHS-W-SS-1	\$142	N/A	-	1 Hole Splash	-	-	12" (w) x 14 1/2" (d)
BKHS-W-SS-1-SS	\$212	N/A	-	1 Hole Splash	Dual	-	12" (w) x 14 1/2" (d)
BKHS-D-SS	\$142	BKHS-D-SS-P-G	\$203	4" O.C. Deck	-	-	12" (w) x 16" (d)
BKHS-D-SS-SS	\$224	BKHS-D-SS-SS-P-G	\$285	4" O.C. Deck	Dual	-	12" (w) x 16" (d)

! Also See Pg. 35



**BKHS-DWSS**  
**Single Removable Side Splash for 9 x 9 Hand Sinks**

to be used with BKHS-D-SS or 16" Deep Hand Sink

LIST PRICE  
**\$47.00**

**BKHS-SWSS**  
**Single Removable Side Splash for 9 x 9 Hand Sinks**

to be used with BKHS-W-SS or 14.5" Deep Hand Sink

LIST PRICE  
**\$47.00**

**16" x 20" Hand Sinks - ADA Hand Sinks - 16" x 16" Hand Sinks**



BKHS-W-1620-P-G  
(Drain Is Included)



BKHS-W-1620-1-SS  
(Drain Is Included)

**BKHS-W-1620 - 16" x 20" T-304 Stainless Steel Hand Sink with Lead Free Faucet**

- Bowl Size: 20" (w) x 16" (d) x 5" (t)
- Mounting Bracket Included
- Drain Included
- Deck Mount Hand Sink Packages Contain Faucet BKD-3G-G
- Splash Mount Hand Sink Packages Contain Faucet BKF-W-3G-G
- Wrist Blade Handles Not Available On "-P" Hand Sink Packages

Sink Only Part Number	NSF	Sink Only LIST PRICE	Faucet & Sink Part Number	Faucet & Sink LIST PRICE	Faucet / Spout Mounting	Side Splash	Drain Size	Overall Dimensions
BKHS-W-1620	✓	\$436	* BKHS-W-1620-P-G	\$499	4" O.C. Splash	-	3 1/2"	24 1/2" (w) x 21 3/4" (d)
BKHS-W-1620-1	✓	\$428	N/A	-	1 Hole Splash	-	3 1/2"	24 1/2" (w) x 21 3/4" (d)
BKHS-W-1620-1-SS	✓	\$460	N/A	-	1 Hole Splash	Dual	3 1/2"	24 1/2" (w) x 21 3/4" (d)



BKHS-ADA-S-P-G



BKHS-ADA-D-P-G

**16" x 14" T-304 ADA Hand Sink with Lead Free Faucet**

- Bowl Size: 14" (w) x 16" (d)
- Overall Size: 20" (w) x 22" (d)
- 1 7/8" Drain Included
- Faucet Includes (Wrist Blade) BKF-WBH Handles

Part Number	Faucet	Faucet / Spout Mounting	LIST PRICE
* BKHS-ADA-S-P-G	BKF-4SM-3G-G	Splash	\$743
BKHS-ADA-S	N/A	Splash	\$598
* BKHS-ADA-D-P-G	BKF-4DM-3G-G	Deck	\$730
BKHS-ADA-D	N/A	Deck	\$598

**NOTE: (\*) We have combined NSF Certified components to offer you a greater value. (Example: BKHS-ADA-S-P) Though these part numbers are not Certified by NSF, each component that makes up the following part numbers are individually Certified by NSF and are thereby approved for use in your facility. For more information, please call 888-310-4393.**



BKHS-D-1616  
Knee Valve & Spout Sold Separately (See Page 24)



BKHS-D-1616-SS  
Knee Valve & Spout Sold Separately (See Page 24)

**BKHS-D-1616 16" x 16" Deck Mount T-304 Hand Sink**

- Bowl Size: 16" x 16" x 10 (d)
- Overall Size: 18" (w) x 20" (d)
- 3 1/2" Drain Included

Part Number	Faucet	LIST PRICE
BKHS-D-1616	N/A	\$428
BKHS-D-1616-SS	N/A	\$462

**BKHS-W-1410-PED Pedestal Hand Sink**

- Bowl Size: 14" x 10" x 5 (d)
- Overall Size: 18" (w) x 20" (d)
- 2" Drain Included
- 33" Work Height



Part Number	Faucet & Foot Valve	LIST PRICE
BKHS-W-1410-PED	N/A	\$728
* BKHS-W-1410-PED-P-G (Includes BKFVSGS-G)	Yes	\$900

One Compartment Drop In Sinks



Also See Pg. 35



BK-DIS-1014-5D-P-G



BK-DIS-2016-12



BK-DIS-1014-5-SS-P-G



BK-DIS-1014-10-SS



**BK-DI1014-SS**  
3-Sided Removable Side  
Splash for 10" x 14" Drop  
In Sinks

LIST PRICE  
**\$110.00**

- Fits ALL 10" x 14" Drop In Sinks
- Sink Sold Separately

**Add a Prep Basket**

See Pg. 91 for more options.



BK-DIS-1515-P-G



BK-DIS-0909-5



BK-DIS-2820



BK-DIS-1014-P-G

Sink Only Part Number	Sink Only LIST PRICE	Sink & Faucet Part Number	Included Faucet	Sink & Faucet LIST PRICE	Included Drain	Bowl Size	Overall Size
BK-DIS-1014-5D	\$185	* BK-DIS-1014-5D-P-G	BKD-3G-G	\$246	BKDR-4	10" x 14" x 5" (d)	12 1/4" x 18" x 5" (d)
BK-DIS-1515	\$137	* BK-DIS-1515-P-G	BKD-3G-G	\$198	BKDR-4	12" x 10" x 5 3/4" (d)	15 1/16" x 15 1/16" x 5 3/4" (d)
BK-DIS-2016-8	\$415	* BK-DIS-2016-8-P-G	BKD-3G-G	\$476	BKDR-4	20" x 16" x 8" (d)	23" x 21" x 8" (d)
BK-DIS-2016-12	\$519	* BK-DIS-2016-12-P-G	BKD-3G-G	\$580	BKDR-4	20" x 16" x 12" (d)	23" x 21" x 12" (d)
BK-DIS-1014-5-SS	\$307	* BK-DIS-1014-5-SS-P-G	BKD-3G-G	\$368	BKDR-4	10" x 14" x 5" (d)	18 1/2" x 12 3/8" x 10 1/2" (d)
BK-DIS-1014-10-SS	\$309	* BK-DIS-1014-10-SS-P-G	BKD-3G-G	\$370	BKDR-4	10" x 14" x 9" (d)	18 7/8" x 12 3/8" x 15 1/4" (d)
BK-DIS-1014-10	\$299	* BK-DIS-1014-10-P-G	BKD-3G-G	\$360	BKDR-4	10" x 14" x 9" (d)	18" x 12" x 9 3/8" (d)
BK-DIS-0909-5	\$281	* BK-DIS-0909-5-P-G	BKD-3G-G	\$342	BKDR-2	9" x 9" x 5" (d)	12" x 14" x 5" (d)
BK-DIS-2820	\$831	* BK-DIS-2820-P-G	BKD-5G-G	\$896	BKDR-4	28" x 20" x 12" (d)	31" x 25" x 12" (d)

Two Compartment Drop In Sinks



BK-DIS-1014-2



BK-DIS-2016-2



BK-DIS-1416-2

Sink Only Part Number	Sink Only LIST PRICE	Sink & Faucet Part Number	Included Faucet	Sink & Faucet LIST PRICE	Included Drain	Bowl Size	Overall Size
BK-DIS-1014-2	\$345	* BK-DIS-1014-2-P-G	BKD-5G-G	\$410	(2) BKDR-4	10" x 14" x 10" (d)	24" x 18" x 10" (d)
BK-DIS-2016-2	\$623	* BK-DIS-2016-2-P-G	BKD-8G-G	\$692	(2) BKDR-4	20" x 16" x 12" (d)	45 5/16" x 21" x 12" (d)
BK-DIS-1416-2	\$519	* BK-DIS-1416-2-P-G	BKD-8G-G	\$588	(2) BKDR-4	14" x 16" x 10" (d)	33 3/8" x 21" x 10" (d)

**NOTE: (\*) We have combined NSF Certified components to offer you a greater value.** (Example: BK-DIS-1014-5-SS-P-G) **Though these part numbers are not Certified by NSF, each component that makes up the following part numbers are individually Certified by NSF and are thereby approved for use in your facility. For more information, please call 888-310-4393.**

## Three Compartment Drop In Sinks - Drop In Ice Bins - Water Stations



### Three Compartment Drop In Sinks



BK-DIS-1014-3-12T  
w/ Marine Edge



BK-DIS-1620-3ME  
w/ Marine Edge



BK-DIS-1620-3  
Accommodates  
(2) 4" o/c Faucets

Sink Only Part Number	Sink Only LIST PRICE	Sink & Faucet Part Number	Included Faucet	Sink & Faucet LIST PRICE	Included Drain	Bowl Size	Overall Size
BK-DIS-1014-3	\$458	*BK-DIS-1014-3-P-G	BKD-8G-G	\$527	(3) BKDR-4	10" x 14" x 10" (d)	36" x 18" x 10" (d)
BK-DIS-1620-3	\$935	*BK-DIS-1620-3-P-G	(2) BKD-10-G	\$1,057	(3) BKDR-4	16" x 20" x 12" (d)	56" x 25" x 12" (d)
BK-DIS-1620-3ME	\$999	*BK-DIS-1620-3ME-P-G	(2) BKD-10-G	\$1,121	(3) BKDR-4	16" x 20" x 12" (d)	58" x 26" x 12" (d)
BK-DIS-1014-3-12T	\$699	*BK-DIS-1014-3-12T-P-G	BK8D-8-G	\$782	(3) BKDR-4	10" x 14" x 10" (d)	58 1/8" x 20" x 10 5/8"
BK-DIS-1014-3-18T	\$769	*BK-DIS-1014-3-18T-P-G	BK8D-8-G	\$852	(3) BKDR-4	10" x 14" x 10" (d)	70 1/8" x 20" x 10 5/8"

### BK-DIBL Drop In Ice Bin w/ Lid

• Includes BKDR-325CP Drain



Part Number	Size	Basin Size	LIST PRICE
BK-DIBL-1218	12" x 18"	9" x 13" x 10"	\$387
BK-DIBL-2218	22" x 18"	18" x 13" x 10"	\$574
BK-DIBL-2818	28" x 18"	24" x 13" x 10"	\$657
BK-DIBL-3418	34" x 18"	30" x 13" x 10"	\$770

### BK-DIBHL-2118 Drop In Ice Bin w/ Sink

- Basin Size: 9" (w) x 13" (d) x 11" (h)
- Overall Size: 21" (w) x 18" (d) x 12" (h)
- Includes Drains: BKDR-2 & BKDR-325CP
- Sink Bowl Size: 11 1/2" (w) x 8 1/2" (d) x 5 1/2" (h)



Part Number	Faucet	LIST PRICE
BK-DIBHL-2118	N/A	\$680
BK-DIBHL-2118-P-G	BKD-3G-G	\$738



BK-WS-1SGF-G

### BK-WS-1SGF-G - Glass Filler Water Station

- Stainless Steel
- O.A. Dimensions 13 3/4" (w) x 10 3/4" (d) x 1 3/4" (h)
- Locking Clip For Continuous Flow

Part Number	Details	LIST PRICE
BKF-SGF-G	Faucet Only	\$150
BK-WS	Sink Only	\$81
* BK-WS-1SGF-G	Faucet & Sink Kit	\$218



BK-DIWSBL-2118G-P-G



BK-DIWSBL-2118X-P-G

### BK-DIWSBL Drop In Ice Bin w/ Water Station

- Basin Size: 9" (w) x 13" (d) x 11" (h)
- Includes Drains: BKDR-15CP & BKDR-325CP

Part Number	Faucet	Overall Size	LIST PRICE
BK-DIWSBL-2118G	N/A	21" w x 18" d x 13" h	\$753
BK-DIWSBL-2118G-P-G	BKF-SGF-G	21" w x 18" d x 13" h	\$882
BK-DIWSBL-2118X	N/A	18" w x 21" d x 13" h	\$753
BK-DIWSBL-2118X-P-G	BKF-SGF-G	18" w x 21" d x 13" h	\$882

**NOTE: (\*) We have combined NSF Certified components to offer you a greater value. (Example: BK-WS-1SGF-G) Though these part numbers are not Certified by NSF, each component that makes up the following part numbers are individually Certified by NSF and are thereby approved for use in your facility. For more information, please call 888-310-4393.**

**BUNDLE & SAVE**



**Bundle Any Soiled Dish Table and Save.** A significant advantage for you and your customers. Every soiled dish table needs one of the following bundle accessories for final installation. Save yourself time and create bigger margins with the BK Resources Bundle & Save options.

*Savings shown for each bundle is compared to purchasing each part individually at standard pricing.*

**-P-G**  
**SAVE \$20**



**BUNDLE #1**  
ADD "-P-G" TO ANY SOILED DISH TABLE PART #

**-P2-G**  
**SAVE \$30**



**BUNDLE #2**  
ADD "-P2-G" TO ANY SOILED DISH TABLE PART #

+

BK-SDTS

**-P3-G**  
**SAVE \$40**



**BUNDLE #3**  
ADD "-P3-G" TO ANY SOILED DISH TABLE PART #

+

BK-PRB-5



Shown  
BKSDT-3-20-12-20RS

**BKSDT - Three Compartment Dish Table with S/S Legs & End Bracing**



- T-304 18 ga Stainless Steel Top
- Stainless Steel Legs & End Bracing
- 20" x 20" x 12" (d) Bowls
- 1 5/8" Rolled Edge
- (3) BKDR-4 Basket Drains Included
- (2) BK-SDTS Tray Guides
- (1) BK-PRB-5 Pre-Rinse Basket

Part Number	Dish Machine	Bowl(s) Side	LIST PRICE
BKSDT-3-20-12-20LS	Attaches to Right Side	Left	\$1,768
BKSDT-3-20-12-20RS	Attaches to Left Side	Right	\$1,768

*\*Recommended Pre-Rinse Unit: BKF-SMPR-WB-AF14-G (See Page 15).*



**BKSDT - Right Side S/S Soiled Dish Table with Galvanized Legs**

- T-304 18 ga Stainless Steel Top
- 20" x 20" x 8" Welded Bowl
- 1 5/8" Rolled Edge
- (BKDR-4) 3 1/2" Drain Included
- 30 3/8" O.A Front to Back



**-P-G**  
SAVE \$20  
Based on individual pricing

**-P2-G**  
SAVE \$30  
Based on individual pricing

**-P3-G**  
SAVE \$40  
Based on individual pricing

Part Number	NSF	Length	Legs & Bracing	LIST PRICE	Bundle #1 Price	Bundle #2 Price	Bundle #3 Price
BKSDT-26-R	✓	26"	Galvanized	\$530	\$828	\$924	\$1,000
BKSDT-36-R	✓	36"	Galvanized	\$564	\$861	\$959	\$1,034
BKSDT-48-R	✓	48"	Galvanized	\$645	\$942	\$1,038	\$1,115
BKSDT-60-R	✓	60"	Galvanized	\$713	\$1,011	\$1,109	\$1,184
BKSDT-72-R	✓	72"	Galvanized	\$840	\$1,137	\$1,236	\$1,310

**BKSDT - Right Side S/S Soiled Dish Table with S/S Legs**



Part Number	NSF	Length	Legs & Bracing	LIST PRICE	Bundle #1 Price	Bundle #2 Price	Bundle #3 Price
BKSDT-26-R-SS	✓	26"	Stainless	\$622	\$919	\$1,015	\$1,082
BKSDT-36-R-SS	✓	36"	Stainless	\$657	\$953	\$1,050	\$1,127
BKSDT-48-R-SS	✓	48"	Stainless	\$736	\$1,034	\$1,132	\$1,206
BKSDT-60-R-SS	✓	60"	Stainless	\$807	\$1,102	\$1,200	\$1,277
BKSDT-72-R-SS	✓	72"	Stainless	\$934	\$1,229	\$1,327	\$1,402

Upgrade To  
S/S Legs And  
Bracing Use  
"-SS" Part #

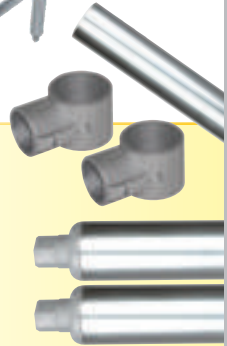

**S/S Legs and Bracing Kit**

• Sold separately

Part Number	LIST PRICE
BKL-DT-SS	\$101



**BKSDT - Left Side S/S Soiled Dish Table with Galvanized Legs**

- T-304 18 ga Stainless Steel Top
- 20" x 20" x 8" Welded Bowl
- 1 5/8" Rolled Edge
- (BKDR-4) 3 1/2" Drain Included
- 30 3/8" O.A Front to Back



**-P-G**  
SAVE \$20  
Based on individual pricing

**-P2-G**  
SAVE \$30  
Based on individual pricing

**-P3-G**  
SAVE \$40  
Based on individual pricing

Part Number	NSF	Length	Legs & Bracing	LIST PRICE	Bundle #1 Price	Bundle #2 Price	Bundle #3 Price
BKSDT-26-L	✓	26"	Galvanized	\$530	\$828	\$924	\$1,000
BKSDT-36-L	✓	36"	Galvanized	\$564	\$861	\$959	\$1,034
BKSDT-48-L	✓	48"	Galvanized	\$645	\$942	\$1,038	\$1,115
BKSDT-60-L	✓	60"	Galvanized	\$713	\$1,011	\$1,109	\$1,184
BKSDT-72-L	✓	72"	Galvanized	\$840	\$1,138	\$1,236	\$1,310

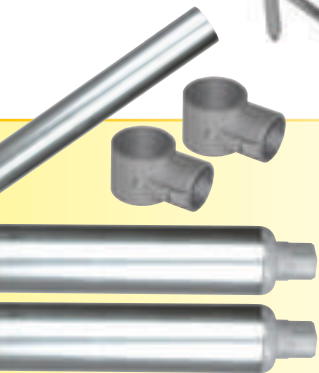

Upgrade To  
S/S Legs And  
Bracing Use  
"-SS" Part #

**S/S Legs and Bracing Kit**

• Sold separately

Part Number	LIST PRICE
BKL-DT-SS	\$101

**BKSDT - Left Side S/S Soiled Dish Table with S/S Legs**



Part Number	NSF	Length	Legs & Bracing	LIST PRICE	Bundle #1 Price	Bundle #2 Price	Bundle #3 Price
BKSDT-26-L-SS	✓	26"	Stainless	\$622	\$919	\$1,015	\$1,092
BKSDT-36-L-SS	✓	36"	Stainless	\$657	\$953	\$1,050	\$1,127
BKSDT-48-L-SS	✓	48"	Stainless	\$736	\$1,034	\$1,132	\$1,206
BKSDT-60-L-SS	✓	60"	Stainless	\$807	\$1,102	\$1,200	\$1,278
BKSDT-72-L-SS	✓	72"	Stainless	\$934	\$1,229	\$1,327	\$1,402

**BKCDT - Right Side S/S Clean Dish Table with Galvanized Legs**

- T-304 18 ga Stainless Steel Top
- 10" Backsplash
- 1 5/8" Rolled Edge



Part Number	NSF	Length	Legs & Bracing	LIST PRICE
BKCDT-26-R	✓	26"	Galvanized	\$347
BKCDT-36-R	✓	36"	Galvanized	\$412
BKCDT-48-R	✓	48"	Galvanized	\$493
BKCDT-60-R	✓	60"	Galvanized	\$595
BKCDT-72-R	✓	72"	Galvanized	\$701



**BKCDT - Right Side S/S Clean Dish Table with S/S Legs**



Part Number	NSF	Length	Legs & Bracing	LIST PRICE
BKCDT-26-R-SS	✓	26"	Stainless	\$437
BKCDT-36-R-SS	✓	36"	Stainless	\$495
BKCDT-48-R-SS	✓	48"	Stainless	\$576
BKCDT-60-R-SS	✓	60"	Stainless	\$680
BKCDT-72-R-SS	✓	72"	Stainless	\$784

**Upgrade To S/S Legs And Bracing Use "-SS" Part #**

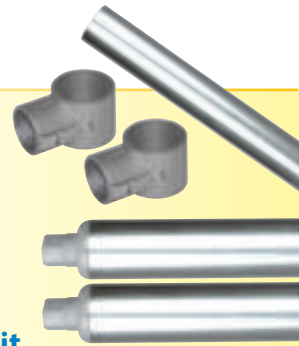

**S/S Legs and Bracing Kit**

- Sold separately

Part Number	LIST PRICE
BKL-DT-SS	\$101



**BKCDT - Left Side S/S Clean Dish Table with Galvanized Legs**

- T-304 18 ga Stainless Steel Top
- 10" Backsplash
- 1 5/8" Rolled Edge

- 1 5/8" Rolled Edge



Part Number	NSF	Length	Legs & Bracing	LIST PRICE
BKCDT-26-L	✓	26"	Galvanized	\$347
BKCDT-36-L	✓	36"	Galvanized	\$412
BKCDT-48-L	✓	48"	Galvanized	\$493
BKCDT-60-L	✓	60"	Galvanized	\$595
BKCDT-72-L	✓	72"	Galvanized	\$701

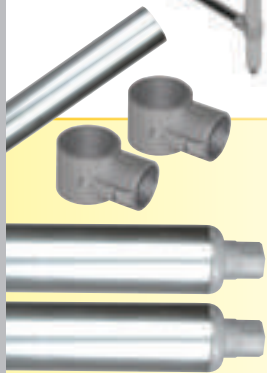

**Upgrade To S/S Legs And Bracing Use "-SS" Part #**

**S/S Legs and Bracing Kit**

- Sold separately

Part Number	LIST PRICE
BKL-DT-SS	\$101

**BKCDT - Left Side S/S Clean Dish Table with S/S Legs**



Part Number	NSF	Length	Legs & Bracing	LIST PRICE
BKCDT-26-L-SS	✓	26"	Stainless	\$437
BKCDT-36-L-SS	✓	36"	Stainless	\$495
BKCDT-48-L-SS	✓	48"	Stainless	\$576
BKCDT-60-L-SS	✓	60"	Stainless	\$680
BKCDT-72-L-SS	✓	72"	Stainless	\$784

Dish Table Kits - Dish Table Accessories

DISH TABLE KITS

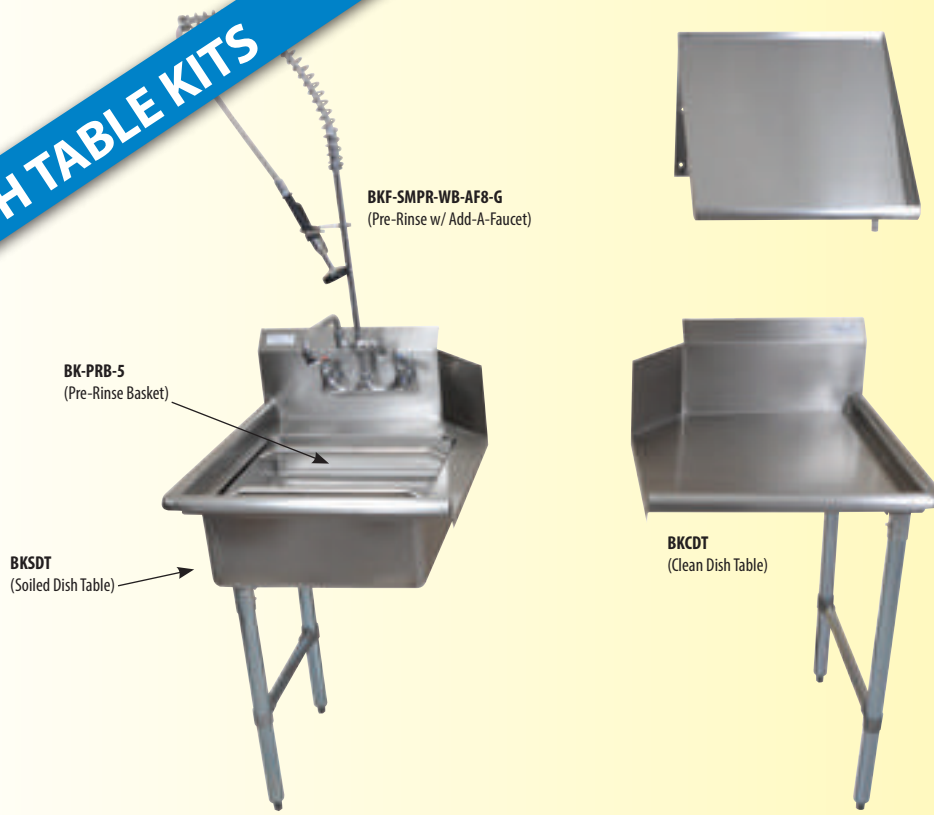

BK-SSH  
(Slant Rack)

BKF-SMPR-WB-AF8-G  
(Pre-Rinse w/ Add-A-Faucet)

BK-PRB-5  
(Pre-Rinse Basket)

BKSDT  
(Soiled Dish Table)

BKCDT  
(Clean Dish Table)

**SAVE \$80**  
When you order any of our  
**BKDTK - Dish Table Kits**

**BKDTK - Dish Table Kits**



Kit Part Number	Clean Dish Table	Soiled Dish Table	Slant Rack Shelf	Pre-Rinse Basket	Pre-Rinse	LIST PRICE
BKDTK-26-L-G	BKCDT-26-R	BKSDT-26-L	BK-SSH-21	BK-PRB-5	BKF-SMPR-WB-AF8-G	\$1,484
BKDTK-26-R-G	BKCDT-26-L	BKSDT-26-R	BK-SSH-21	BK-PRB-5	BKF-SMPR-WB-AF8-G	\$1,484
BKDTK-48-L-G	BKCDT-48-R	BKSDT-48-L	BK-SSH-42	BK-PRB-5	BKF-SMPR-WB-AF8-G	\$1,744
BKDTK-48-R-G	BKCDT-48-L	BKSDT-48-R	BK-SSH-42	BK-PRB-5	BKF-SMPR-WB-AF8-G	\$1,744
BKDTK-72-L-G	BKCDT-72-R	BKSDT-72-L	BK-SSH-63	BK-PRB-5	BKF-SMPR-WB-AF8-G	\$2,283
BKDTK-72-R-G	BKCDT-72-L	BKSDT-72-R	BK-SSH-63	BK-PRB-5	BKF-SMPR-WB-AF8-G	\$2,283



**BK-SDTS**  
Tray Slide

- T-304 Stainless Steel
- #4 Polish
- 3/16" Bar Stock

Part Number	Fits Bowl Size (wx l)	LIST PRICE
BK-SDTS	20"x20"	\$121
BK-SDTS-1824	18"x24"	\$135



**BK-PRB-5**  
Pre Rinse Basket **LIST PRICE \$218.00**

- 20" (l) x 20" (w) x 5" (d)
- 18 ga. T-304 Stainless Steel
- Designed for Easy Use



**BK-TSH**  
Stainless Steel Tubular Shelf

- T-304 18 ga. Stainless Steel
- 1 5/8" O.D. Stainless Tubing

Part Number	Length	LIST PRICE
BK-TSH-22	22"	\$189
BK-TSH-42	42"	\$243
BK-TSH-63	63"	\$300

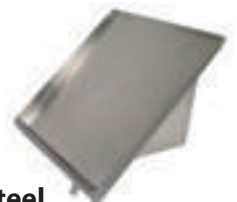

**BK-SSH**  
Stainless Steel Slant Rack Shelf

- T-304 18ga. Stainless Steel
- S/S Weep Requires 1" Nylon Tubing

Part Number	Length	LIST PRICE
BK-SSH-21	21"	\$181
BK-SSH-42	42"	\$241
BK-SSH-63	63"	\$318



**BKUCDT- Left Side - Undercounter Dish Table**

- T-304 18 ga Stainless Steel
- Galvanized or S/S Legs & Bracing
- Adjustable High Impact Corrosion Resistant Feet
- 20" x 20" x 8" Deep Sink
- (BKDR-4) 3 1/2" Drains Included
- 10" Backsplash
- Compatible with 8" Faucets
- Sink on Left Side



**-P-G**  
**SAVE \$20**  
Based on individual pricing

**-P3-G**  
**SAVE \$40**  
Based on individual pricing

⚠ See Bundle Package Details on Pg. 41

Part Number	Length	Legs & Bracing	LIST PRICE	Bundle #1 Price	Bundle #3 Price
BKUCDT-50-L	50"	Galvanized	\$495	\$792	\$965
BKUCDT-60-L	60"	Galvanized	\$541	\$838	\$1,011
BKUCDT-50-L-SS	50"	Stainless	\$587	\$884	\$1,057
BKUCDT-60-L-SS	60"	Stainless	\$634	\$930	\$1,102

**Customer Applications**



**BKUCDT- Right Side - Undercounter Dish Table**

- T-304 18 ga Stainless Steel
- Galvanized or S/S Legs & Bracing
- Adjustable High Impact Corrosion Resistant Feet
- 20" x 20" x 8" Deep Sink
- (BKDR-4) 3 1/2" Drains Included
- 10" Backsplash
- Compatible with 8" Faucets
- Sink on Right Side



**-P-G**  
**SAVE \$20**  
Based on individual pricing

**-P3-G**  
**SAVE \$40**  
Based on individual pricing

⚠ See Bundle Package Details on Pg. 41

Part Number	Length	Legs & Bracing	LIST PRICE	Bundle #1 Price	Bundle #3 Price
BKUCDT-50-R	50"	Galvanized	\$495	\$792	\$965
BKUCDT-60-R	60"	Galvanized	\$541	\$838	\$1,011
BKUCDT-50-R-SS	50"	Stainless	\$587	\$884	\$1,057
BKUCDT-60-R-SS	60"	Stainless	\$634	\$930	\$1,102



**LEFT SIDE SOILED DISH TABLE LAYOUT**

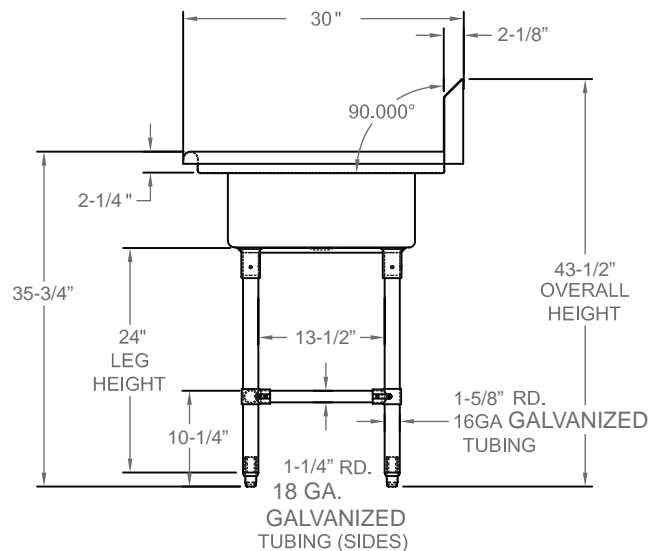
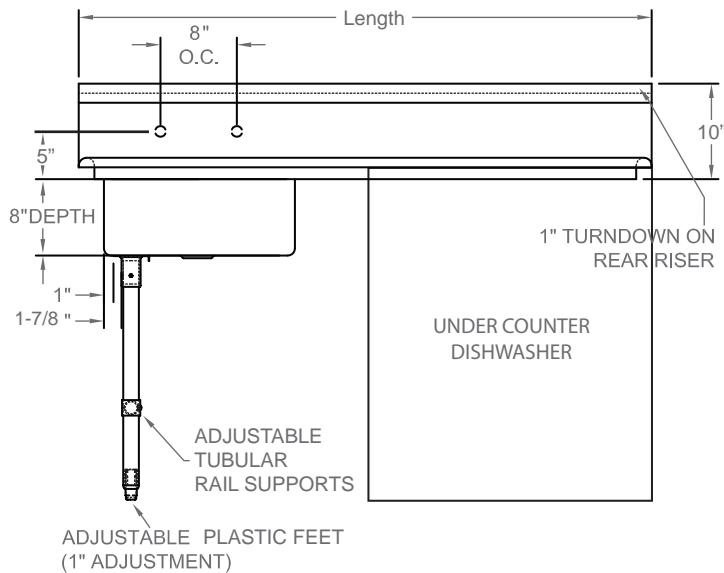

**BK-SGI - Steel Grease Interceptor**

- Semi-automatic Drawoff Grease Interceptor
- Epoxy Coated Steel
- Drawoff Hose
- Shut-off Valve
- Easy Maintenance

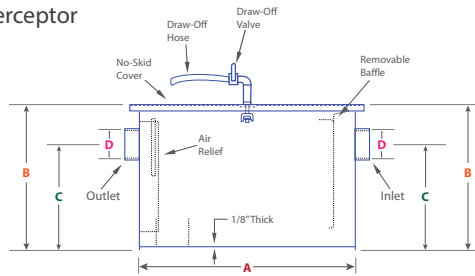

**NEW PRICES!**

Part Number	GPM Capacity	Grease Cap (lbs.)	A	B	C	D	Width	LIST PRICE
BK-SGI-8	4	8 lbs.	14 1/8"	11 1/4"	7 1/2"	2"	10 1/2"	\$889
BK-SGI-14	7	14 lbs.	16 1/8"	12 1/8"	8 1/8"	2"	13 1/2"	\$999
BK-SGI-20	10	20 lbs.	20 1/8"	12 1/8"	8 1/8"	2"	14 1/2"	\$1,009
BK-SGI-30	15	30 lbs.	20 1/2"	13 7/8"	10 3/8"	2"	16"	\$1,029
BK-SGI-40	20	40 lbs.	22 1/2"	15"	11 1/2"	3"	16"	\$1,400
BK-SGI-50	25	50 lbs.	24 1/2"	16 1/2"	12"	3"	17 1/2"	\$1,550
BK-SGI-70	35	70 lbs.	28 1/2"	19 1/2"	14 1/8"	3"	18"	\$1,725
BK-SGI-100	50	100 lbs.	30 1/2"	21 1/2"	16 1/8"	4"	22 1/4"	\$1,950



**BK-GT-SEAL**  
Heavy Duty Grease Trap Replacement Seal

LIST PRICE  
**\$50.00**

- Easy Installation
- Works with all BK-GT Grease Traps
- Please specify size of Grease Trap
- 15/16" x 3/4" x 10'

**BK-GT-EXT - Grease Trap Extender**

- Extends Grease Trap 6" Higher
- Does NOT increase Capacity
- Lid and Grease Trap Not Included



Part Number	Fits	LIST PRICE
BK-GT-EXT8	8lb. BK-GT-8	\$70
BK-GT-EXT14	14lb. BK-GT-14	\$78
BK-GT-EXT20	20lb. BK-GT-20	\$88
BK-GT-EXT30	30lb. BK-GT-30	\$100
BK-GT-EXT40	40lb. BK-GT-40	\$104
BK-GT-EXT50	50lb. BK-GT-50	\$108
BK-GT-EXT70	70lb. BK-GT-70	\$110
BK-GT-EXT100	100lb. BK-GT-100	\$122





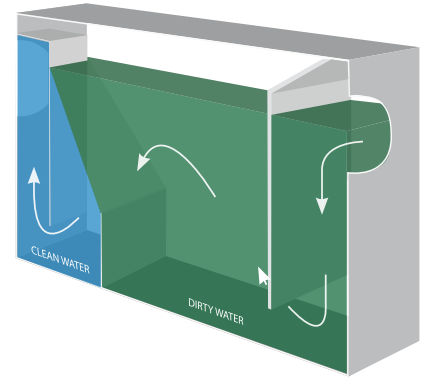
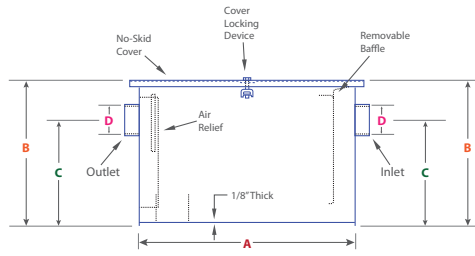

WARRANTED  
**1**  
YEAR



### BK-GT - Carbon Steel Grease Traps

- Constructed of 11 ga Carbon Steel w/ Corrosion Resistant Coating
- Non-Skid Deck Plate
- Removable Baffles for Ease of Maintenance
- Main Body of Grease Trap Suspended Above Floor to Avoid Corrosive Environment and Extend Life
- No Hub Connections
- T-Vent Provided
- Designed for removing and isolating F.O.G. ( Fat, Oil, Grease ) from wastewater wherever Food is Prepared

Part Number	GPM Capacity	Grease Cap (lbs.)	A	B	C	D	Width	LIST PRICE
BK-GT-8	4	8 lbs.	14 1/8"	11 1/4"	7 1/2"	2"	10 1/2"	\$210
BK-GT-14	7	14 lbs.	16 1/8"	12 1/8"	8 1/8"	2"	13 1/2"	\$232
BK-GT-20	10	20 lbs.	20 1/8"	12 1/8"	8 1/8"	2"	14 1/2"	\$254
BK-GT-30	15	30 lbs.	20 1/2"	13 7/8"	10 3/8"	2"	16"	\$362
BK-GT-40	20	40 lbs.	22 1/2"	15"	11 1/2"	3"	16"	\$466 
BK-GT-50	25	50 lbs.	24 1/2"	16 1/2"	12"	3"	17 1/2"	\$582 
BK-GT-70	35	70 lbs.	28 1/2"	19 1/2"	14 1/8"	3"	18"	\$676 
BK-GT-100	50	100 lbs.	30 1/2"	21 1/2"	16 1/8"	4"	22 1/4"	\$768 

• BK-GT-8, BK-GT-14, BK-GT-20, BK-GT-30 Listed by IAPMO R&T File #C-7235

• BK-GT-40, BK-GT-50, BK-GT-70, BK-GT-100 Listed by IAPMO R&T File #6728

## What Size Grease Trap Do I Need?

Use this formula or calculation to find the right size grease trap for your kitchen setup.\*

<b>1.</b>	<b>Length X Width X Depth of your bowls</b> (All Total. Example: a 3 Compartment Sink - add up each compartment LxWxD for a total)	+
<b>2.</b>	<b>Multiply that number by the number of bowls</b> (Example: a 3 Compartment Sink, multiply by 3)	X
<b>3.</b>	<b>Divide by 231</b> (This gives you contents in gallons.)	÷
<b>4.</b>	<b>Multiply by .75</b> (This gives you grease capacity in lbs.)	X
<b>5.</b>	<b>Look up capacity (lbs.) to find grease trap model you will need</b>	<b>TOTAL</b>

\* Always refer to Local Codes.

Thanks to The Plumbing & Drainage Institute for this formula.

NEW

# Refrigeration

Back Bars • Bottle Coolers • Direct Draw



### Enhanced Refrigeration System

- Oversized and balanced
- CFC free R-134a Refrigerators maintain temps between 28°F to 38°F
- Keeps beers ice cold
- ETL Certified

### Heavy Duty Construction

- 18 gauge Stainless Steel Top
- Wear resistant black vinyl exterior
- Galvanized interior with coved corners
- Analog Thermostat
- Stainless Steel Floors

### Warranty

- One Year labor and parts warranty
- Five Year compressor warranty

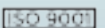
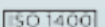



# BACK BARS

**• Heavy Duty Construction**

Top is made of solid 18 gauge stainless steel for easy cleaning  
Wear resistant black vinyl exterior. Galvanized interior with SS floor and coved corners

**• Field Interchangeable Doors**

Solid to Glass and Glass to Solid based on operator's needs

**• Dual Pane Thermal Glass (G Models only)**

Black aluminum frame, merchandise your product with greater visibility

**• Enhanced Refrigeration System**

Factory engineered oversized and balanced refrigeration system. CFC free R-134a refrigerators maintain temperature between 33°F to 38°F, keeping beers ice cold.

**• Left Side Mounted Compressor & Front Breathing**

System allows easy service & unrestricted placement for the unit even in narrow spaces

**• Analog Thermostat**

**• Stay Open Doors with Locks & LED Light**

90° stay open door feature and LED light underneath the mullion

**• Adjustable, Coated Wire Shelves**

Create three levels to fit tall boy beers

**• Magnetic Gasket**

One Piece gasket removable without tools for ease of cleaning and replacement



**Options**

- Additional flat or bottle rail shelves
- 3" casters

MODEL	DOORS	CAPACITY 12 Oz Can	SHELVES	AMPS	HP	VOLTAGE	NEMA PLUG	CORD LENGTH	UNIT SIZE	SHIPPING WT.	CUBES	LIST PRICE
<b>SOLID DOOR</b>												
BB-2-59	2	852	4	6.6	1/3	115/60/1	5-15P	8'	59 1/2" x 28" x 37"	343	51	\$3800
BB-2-69	2	1,014	4	6.6	1/3	115/60/1	5-15P	8'	69 1/2" x 28" x 37"	370	59	\$4200
BB-3-95	3	1,302	6	7.2	1/3	115/60/1	5-15P	8'	95 1/2" x 28" x 37"	429	81	\$4600
<b>GLASS DOOR</b>												
BB-2G-59	2	852	4	6.6	1/3	115/60/1	5-15P	8'	59 1/2" x 28" x 37"	343	51	\$4100
BB-2G-69	2	1,014	4	6.6	1/3	115/60/1	5-15P	8'	69 1/2" x 28" x 37"	370	59	\$4455
BB-3G-95	3	1,302	6	7.2	1/3	115/60/1	5-15P	8'	95 1/2" x 28" x 37"	429	81	\$5400





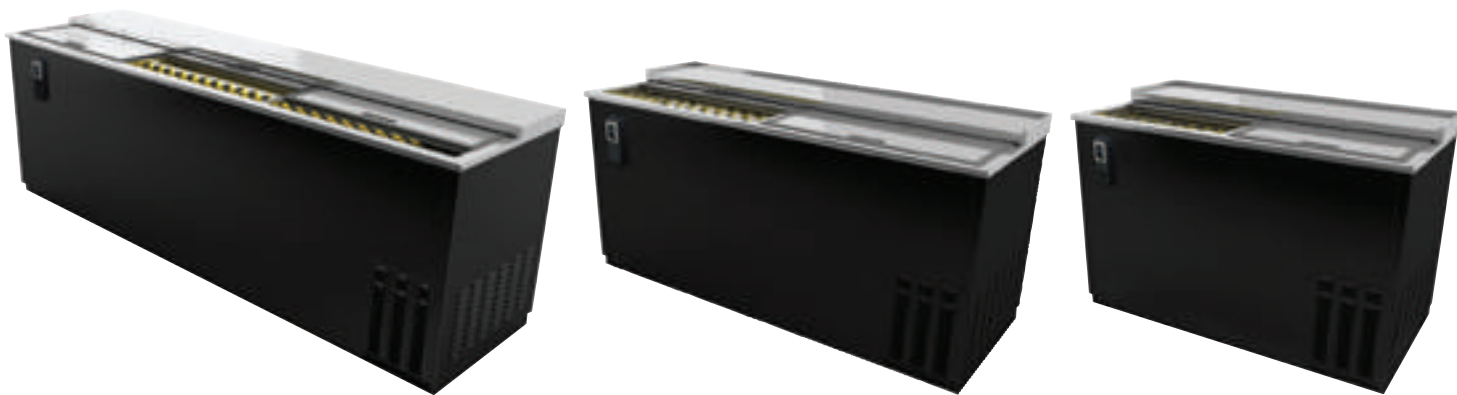

# BOTTLE COOLERS

**• Heavy Duty Construction**

Top is made of solid 18 gauge stainless steel for easy cleaning  
 Wear resistant black vinyl exterior  
 Galvanized interior with SS floor and coved corners  
 Anodized aluminum bottle rails  
 Drain located in rear of cabinet to keep unit pristine at all times

**• Enhanced Refrigeration System**

Factory engineered oversized and balanced refrigeration system.  
 CFC-free R-134a refrigerators maintain temperature between 33°F to 38°F  
 Keeps beers ice Cold.

**• Analog Thermostat**

**• High Density Polyurethane Insulation**

The entire unit has 1.5" CFC-free polyurethane insulation foamed in place for extra strength and energy efficiency

**• Rugged, Removable Bottle Cap Opener & Cap Catcher**

**• Heavy Duty Adjustable Bin Dividers, Epoxy Coated**



**Options**

- Additional bin dividers
- 3" casters

MODEL	DOORS	CAPACITY 12 Oz Can	CAPACITY 12 Oz Bottles	AMPS	HP	VOLTAGE	NEMA PLUG	CORD LENGTH	UNIT SIZE	SHIPPING WT.	CUBES	LIST PRICE
<b>SOLID DOOR</b>												
BC-2-50	2	704	286	5.9	1/4	115/60/1	5-15P	8'	50 1/2" x 26 1/2" x 33 3/8"	260	37	\$2600
BC-2-65	2	890	360	6.2	1/3	115/60/1	5-15P	8'	65 1/2" x 26 1/2" x 33 3/8"	310	50.5	\$3100
BC-3-95	3	1,150	547	6.2	1/2	115/60/1	5-15P	8'	95" x 26 1/2" x 33 3/8"	508	69	\$4200





# DRAFT BEER COOLERS

**• Heavy Duty Construction**

Top is made of solid 18 gauge stainless steel, including drip tray(s), for easy cleaning  
Wear resistant black vinyl exterior. Galvanized interior with SS floor and coved corners  
Drain is located in rear of cabinets to keep unit pristine at all times

**• Polished Stainless Steel Towers**

Draft towers are three inches in diameter, stainless steel with polyurethane insulation.  
The continuous flow of cold air throughout the tower results in a perfect pour

**• Interchangeable Doors**

Field interchangeable doors from Solid to Glass or Glass to Solid.

**• Enhanced Refrigeration System**

Factory engineered oversized and balanced refrigeration system. CFC free R-134a refrigerators maintain temperature between 33°F to 38°F, keeping beers ice cold.

**• Side Mounted Compressor & Front Breathing**

System allows easy service & unrestricted placement of the unit

**• Analog Thermostat**

**• Stay Open Doors with Locks & LED Light**

90° stay open door feature and LED light underneath the mullion

**• Open Cavity**

Evaporator located on left side above compressor provides an open cavity and more working room

**• Magnetic Gasket**

One Piece gasket removable without tools for ease of cleaning and replacement

**• DBC-11-24**

Single keg units are rear breathing with internal drain, internal CO2 chain harness and knockout place for external CO2 PLACEMENT.  
Includes 5" casters



**Options**

- Single / Double draft towers
- 3" casters
- 3-way gas valve & 4-way gas valve
- Dunnage floor
- 220v-50Hz-1Phase

MODEL	DOORS	TOWERS	TAPS	KEGS	AMPS	HP	VOLTAGE	NEMA PLUG	UNIT SIZE	SHIPPING WT.	CUBES	LIST PRICE
<b>SOLID DOOR</b>												
DBC-11-24	1	1	1	1	2.5	1/6	115/60/1	5-15P	23 3/4" x 27 3/4" x 40 3/4"	165	23	\$2645
DBC-22-59	2	2	2	3	6.6	1/3	115/60/1	5-15P	59 1/2" x 28" x 37"	343	51	\$4000
DBC-22-69	2	2	2	3	6.6	1/3	115/60/1	5-15P	69 1/2" x 28" x 37"	370	59	\$4400
DBC-24-95	3	2	4	5	7.2	1/3	115/60/1	5-15P	69 1/2" x 28" x 37"	429	81	\$5300



### BKUB-WS - Underbar Complete Work Stations



- All 18 ga.T-304 Stainless Steel w/ S/S Legs
- Ice Bin, Blender Station and Drainboard
- Sold as Individual Pieces
- With Lids & Speed Rails
- Includes BKF-4SM2-3G-G Faucet
- Standard 21" Depth & 30" Work Height

Part Number	O.A. Workstation Length	O.A. Drain Board Length	O.A. Ice Bin Length	O.A. Speed Rail Length	O.A. Blender Station Length	LIST PRICE
BKUB-WS-54-GS	54"	12"	24"	24"	18"	\$1,658
BKUB-WS-60-GS	60"	18"	24"	24"	18"	\$1,720
BKUB-WS-66-GS	66"	24"	24"	24"	18"	\$1,772
BKUB-WS-78-GS	78"	30"	30"	30"	18"	\$2,009
BKUB-WS-90-GS	90"	36"	36"	36"	18"	\$2,199
BKUB-WS-114-GS	114"	48"	48"	48"	18"	\$2,364

**SAVE \$60**

Based on individual pricing



### BKUB-WS-IBDB - Underbar Ice Bin / Drainboard Work Stations



- All 18 ga.T-304 Stainless Steel w/ S/S Legs
- Sold as Individual Pieces
- Standard 21" Depth & 30" Work Height
- With Lids & Speed Rails

Part Number	O.A. Work Station Length	O.A. Drainboard Length	O.A. Ice Bin Length	O.A. Speed Rail Length	LIST PRICE
BKUB-WS-IBDB-48S	48"	24"	24"	24"	\$1,215
BKUB-WS-IBDB-60S	60"	30"	30"	30"	\$1,442
BKUB-WS-IBDB-72S	72"	36"	36"	36"	\$1,638
BKUB-WS-IBDB-96S	96"	48"	48"	48"	\$1,808

**SAVE \$40**

Based on individual pricing



### BKUB-WS-BSIB - Underbar Blender Station / Ice Bin Work Stations



- All 18 ga.T-304 Stainless Steel w/ S/S Legs
- Sold as Individual Pieces
- Includes BKF-4SM2-3G-G Faucet
- Standard 21" Depth & 30" Work Height
- With Lids & Speed Rails

Part Number	O.A. Work Station Length	O.A. Speed Rail Length	O.A. Ice Bin Length	O.A. Blender Station Length	LIST PRICE
BKUB-WS-BSIB-42-GS	42"	24"	24"	18"	\$1,360
BKUB-WS-BSIB-48-GS	48"	30"	30"	18"	\$1,550
BKUB-WS-BSIB-54-GS	54"	36"	36"	18"	\$1,689
BKUB-WS-BSIB-66-GS	66"	48"	48"	18"	\$1,792

**SAVE \$40**

Based on individual pricing



STANDARD 21" DEPTH • NOW WITH STAINLESS STEEL LEGS & BRACING

**BKUB-LD - 4 Step Liquor Display**



- T-304 18 ga Stainless Steel
- 1 5/8" SS Legs and Bracing
- Adjustable High Impact Corrosion Resistant Bullet Feet



Part #	O.A. Size: (w x d)	LIST PRICE
BKUB-LD12-21S	12" x 21"	\$659
BKUB-LD18-21S	18" x 21"	\$762
BKUB-LD24-21S	24" x 21"	\$937
BKUB-LD36-21S	36" x 21"	\$1,029



Shallow Mount Application



BKUBS-1410BS-P-G



**BKUBS-1410BS  
14" x 10" Stainless Steel  
Blender Station with Sink**

- Bowl Dimensions : 14" (l) x 10" (w) x 6" (d)
- Overall Dimensions : 18" (l) x 21" (w) x 32 1/2" (h)
- Blender Station Area: 17 3/4" (l) x 8" (w) x 7 1/2" (h)
- 28.5" Working Height
- Accepts 4" O.C. Splash Mount Faucet

Part Number	Faucet	LIST PRICE
BKUBS-1410BSS	N/A	\$445
BKUBS-1410BS-P-GS	BKF-W2-3G-G	\$509

**BKIB - Insulated Ice Bin and Cold Plate**

- T-304 18 ga Stainless Steel
- 7 & 8 Circuit Aluminum Cold Plate
- 32 1/2" Standard Height
- Ice Bin is 12 9/16" Deep



**7 Circuit Insulated Ice Bin & Cold Plate**



Part Number	O.A. Size: (l x w)	Ice Bin Size: (l x w)	Ice Bin Capacity	LIST PRICE
BKIB-CP7-2412-21S	24" x 21"	20" x 18"	80 lbs	\$1,483
BKIB-CP7-3012-21S	30" x 21"	25" x 18"	97 lbs	\$1,541
BKIB-CP7-3612-21S	36" x 21"	31" x 18"	120 lbs	\$1,619
BKIB-CP7-4812-21S	48" x 21"	43" x 18"	167 lbs	\$1,677

**8 Circuit Insulated Ice Bin & Cold Plate**

Part Number	O.A. Size: (l x w)	Ice Bin Size: (l x w)	Ice Bin Capacity	LIST PRICE
BKIB-CP8-2412-21S	24" x 21"	20" x 18"	80 lbs	\$1,541
BKIB-CP8-3012-21S	30" x 21"	25" x 18"	97 lbs	\$1,597
BKIB-CP8-3612-21S	36" x 21"	31" x 18"	120 lbs	\$1,677
BKIB-CP8-4812-21S	48" x 21"	43" x 18"	167 lbs	\$1,735



**BKIB-L - Stainless Steel Ice Bin Lid**

- T-304 18 ga Stainless Steel
- Designed To Fit BKIB Insulated SS Ice Bins ONLY

21" Deep	Fits	LIST PRICE
BKIB-L-2421	BKIB-2412-21	\$164
BKIB-L-3021	BKIB-3012-21	\$184
BKIB-L-3621	BKIB-3612-21	\$205
BKIB-L-4821	BKIB-4812-21	\$226

**BKIB - Insulated Stainless Steel Ice Bin**

- T-304 18 ga Stainless Steel
- 32 1/2" Standard Height
- Ice Bin is 12 9/16" Deep
- Lid Required for Human Consumption

- SS Legs and Bracing
- Adjustable High Impact Corrosion Resistant Bullet Feet
- Includes Drain (BKDR-325CP)



Ice Bin w/o Lid	NSF	LIST PRICE	Ice Bin with Lid	LIST PRICE	O.A. Size: (l x w)	Ice Bin Size: (l x w)	Ice Bin Capacity
BKIB-2412-21S	✓	\$628	BKIB-2412-21-KITS	\$745	24" x 21"	20" x 18"	80 lbs
BKIB-3012-21S	✓	\$787	BKIB-3012-21-KITS	\$930	30" x 21"	25" x 18"	97 lbs
BKIB-3612-21S	✓	\$900	BKIB-3612-21-KITS	\$1,062	36" x 21"	31" x 18"	120 lbs
BKIB-4812-21S	✓	\$981	BKIB-4812-21-KITS	\$1,280	48" x 21"	43" x 18"	167 lbs



BKIB-2412-21-KITS

### STANDARD 21" DEPTH • NOW WITH STAINLESS STEEL LEGS & BRACING

#### BKUBS-1014HS 14" x 10" Stainless Steel Dump Sink



- Bowl Dimensions : 10" (l) x 14" (w) x 6" (d)
- Overall Dimensions : BKUBS-1014HSS (14<sup>1/2</sup>" L x 21" W x 32<sup>1/2</sup>" H)
- BKUBS-1014HSS12 (12" L x 21" W x 32<sup>1/2</sup>" H)
- 28.5" Working Height
- Accepts 4" O.C. Deck Mount Faucet

Now in 12" & 14" wide units!



Part Number	Faucet	LIST PRICE
BKUBS-1014HSS	N/A	\$422
BKUBS-1014HS-P-GS	BKD-6-G	\$480
BKUBS-1014HS12S	N/A	\$410
BKUBS-1014HS12S-P-G	BKD-6-G	\$466

#### BKUB-SS21 Single Removable Side Splash

Also See Pg. 35

LIST PRICE  
\$32.00

- T-304 16 ga Stainless Steel
- Fits BK Resources 21" Standard Underbar Equipment
- 4 Self-Tapping Screws
- Caulking



BKD-10-G

BK-OT-15075

BKDR-2

#### BKUBD-C2121S Corner Drainboard

- Includes Drain (BKDR-15CP)
- SS Legs and Bracing
- Adjustable High Impact Corrosion Resistant Bullet Feet



Part Number	Size: (l x w)	LIST PRICE
BKUBD-C2121S	21" x 21"	\$617

#### BKUBS - Stainless Steel Underbar Sinks



- 18 ga T-304 Stainless Steel
- Integrally Welded Bowls 10"(l) x 14"(w) x 10"(d)
- Stamped and Pitched Drainboards
- SS Legs and Bracing
- Adjustable High Impact Corrosion Resistant Bullet Feet

- Includes:
  - BKD-10-G Faucet
  - BKDR-2 Basket Drains
  - BK-OT-15075 7" Overflow Tubes



All-in-One

#### Underbar Dump Sink with Integral Towel & Soap Dispenser



- T-304 18 ga Stainless Steel
- Adjustable High Impact Corrosion Resistant Bullet Feet
- SS Legs and Bracing
- Adjustable High Impact Corrosion Resistant Bullet Feet
- Includes Strainer Basket, BK-UCSD-1 Soap Dispenser, Basket Drain (BKDR-2)
- Overall Dimensions: BKUBS-1012HST-521S (15"L x 21"W), BKUBS-1012HST-221S (12"L x 21"W)

Part Number	Faucet	LIST PRICE
BKUBS-1012HST-521S	N/A	\$800
BKUBS-1012HST-521S-P-G	BKF-W2-3G-G	\$864
BKUBS-1012HST-221S	N/A	\$790
BKUBS-1012HST-221S-P-G	BKF-W2-3G-G	\$854

#### BKUBD - Stainless Steel Drainboards



- T-304 18 ga Stainless Steel
- SS Legs and Bracing
- Adjustable High Impact Corrosion Resistant Bullet Feet
- Stamped Drainboards
- 32<sup>1/2</sup>" Standard Height
- Includes Drain (BKDR-15CP)

Part Number	Size: (l x w)	LIST PRICE
BKUBD-12-21S	12" x 21"	\$342
BKUBD-18-21S	18" x 21"	\$408
BKUBD-24-21S	24" x 21"	\$457
BKUBD-30-21S	30" x 21"	\$503
BKUBD-36-21S	36" x 21"	\$554
BKUBD-48-21S	48" x 21"	\$618

Part #	# of Length	Bowls	Drainboard Size	Faucet Holes	Sets of	LIST PRICE
					Faucet Holes	
BKUBS-224S	24"	2	N/A	1		\$824
BKUBS-336S	36"	3	N/A	1		\$948
BKUBS-448S	48"	4	N/A	2		\$1,133
BKUBS-236LS	36"	2	(1) L - 12 <sup>3/4</sup> "	1		\$919
BKUBS-236RS	36"	2	(1) R - 12 <sup>3/4</sup> "	1		\$919
BKUBS-248LS	48"	2	(1) L - 24"	1		\$954
BKUBS-248RS	48"	2	(1) R - 24"	1		\$954
BKUBS-248TS	48"	2	(2) - 13 <sup>3/16</sup> "	1		\$954
BKUBS-348LS	48"	3	(1) L - 13 <sup>5/8</sup> "	1		\$987
BKUBS-348RS	48"	3	(1) R - 13 <sup>5/8</sup> "	1		\$987
BKUBS-360LS	60"	3	(1) L - 24 <sup>1/8</sup> "	1		\$1,055
BKUBS-360RS	60"	3	(1) R - 24 <sup>1/8</sup> "	1		\$1,055
BKUBS-360TS	60"	3	(2) - 13 <sup>1/2</sup> "	1		\$1,055
BKUBS-372TS	72"	3	(2) - 19"	1		\$1,125
BKUBS-472TS	72"	4	(2) - 13 <sup>3/4</sup> "	2		\$1,306
BKUBS-384TS	84"	3	(2) - 25"	1		\$1,283
BKUBS-484TS	84"	4	(2) - 19"	2		\$1,512
BKUBS-396TS	96"	3	(2) - 31"	1		\$1,489
BKUBS-496TS	96"	4	(2) - 25"	2		\$1,718

SLIM-LINE 18" DEPTH • NOW WITH STAINLESS STEEL LEGS & BRACING



**BKUB-LD - 4 Step Liquor Display**



- T-304 18 ga Stainless Steel
- 1 5/8" SS Legs and Bracing
- Adjustable High Impact Corrosion Resistant Bullet Feet

Part #	O.A. Size: (w x d)	LIST PRICE
BKUB-LD12-18S	12" x 18"	\$649
BKUB-LD18-18S	18" x 18"	\$747
BKUB-LD24-18S	24" x 18"	\$917
BKUB-LD36-18S	36" x 18"	\$1,009



Customer Applications

**BKIB - Insulated Ice Bin and Cold Plate**



- T-304 18 ga Stainless Steel
- 7 & 8 Circuit Aluminum Cold Plate
- 32 1/2" Standard Height
- Ice Bin is 12 9/16" Deep



**7 Circuit Insulated Ice Bin & Cold Plate**

Part Number	O.A. Size: (l x w)	Ice Bin Size: (l x w)	Ice Bin Capacity	LIST PRICE
BKIB-CP7-2412-18S	24" x 18"	20 <sup>3/8</sup> " x 15"	66 lbs	\$1,483
BKIB-CP7-3012-18S	30" x 18"	25" x 15"	80 lbs	\$1,541
BKIB-CP7-3612-18S	36" x 18"	31" x 15"	100 lbs	\$1,619
BKIB-CP7-4812-18S	48" x 18"	43" x 15"	140 lbs	\$1,677

**8 Circuit Insulated Ice Bin & Cold Plate**

Part Number	O.A. Size: (l x w)	Ice Bin Size: (l x w)	Ice Bin Capacity	LIST PRICE
BKIB-CP8-2412-18S	24" x 18"	20 <sup>3/8</sup> " x 15"	66 lbs	\$1,541
BKIB-CP8-3012-18S	30" x 18"	25" x 15"	80 lbs	\$1,597
BKIB-CP8-3612-18S	36" x 18"	31" x 15"	100 lbs	\$1,677
BKIB-CP8-4812-18S	48" x 18"	43" x 15"	140 lbs	\$1,735

**BKIB-L - Stainless Steel Ice Bin Lid**

- T-304 18 ga Stainless Steel
- Designed To Fit BKIB Insulated S/S Ice Bins ONLY

18" Deep	Fits	LIST PRICE
BKIB-L-2418	BKIB-2412-18	\$164
BKIB-L-3018	BKIB-3012-18	\$184
BKIB-L-3618	BKIB-3612-18	\$205
BKIB-L-4818	BKIB-4812-18	\$226



See Bottle Well Holders on pg. 57

**BK-IBBH**  
Bottle Well Holder

**BKIB - Insulated Stainless Steel Ice Bin**

- T-304 18 ga Stainless Steel
- 32 1/2" Standard Height
- Ice Bin is 12 9/16" Deep
- Lid Required for Human Consumption

- SS Legs and Bracing
- Adjustable High Impact Corrosion Resistant Bullet Feet
- Includes Drain (BKDR-325CP)



Ice Bin w/o Lid	NSF	LIST PRICE	Ice Bin with Lid	LIST PRICE	O.A. Size: (l x w)	Ice Bin Size: (l x w)	Ice Bin Capacity
BKIB-2412-18S	✓	\$618	BKIB-2412-18-KITS	\$735	24" x 18"	20 <sup>3/8</sup> " x 15"	66 lbs
BKIB-3012-18S	✓	\$777	BKIB-3012-18-KITS	\$920	30" x 18"	25" x 15"	80 lbs
BKIB-3612-18S	✓	\$890	BKIB-3612-18-KITS	\$1,052	36" x 18"	31" x 15"	100 lbs
BKIB-4812-18S	✓	\$970	BKIB-4812-18-KITS	\$1,270	48" x 18"	43" x 15"	140 lbs



BKIB-2412-21-KITS  
See pg. 53

### SLIM-LINE 18" DEPTH • NOW WITH STAINLESS STEEL LEGS & BRACING

#### BKUBS-1014HS-18 14" x 10" Stainless Steel Dump Sink



- Bowl Dimensions : 10" (l) x 14" (w) x 6" (d)
- Overall Dimensions : BKUBS-1014HS-18 (14 1/2" L x 21" W x 32 1/2" H)
- BKUBS-1014HS12-18S (12" L x 21" W x 32 1/2" H)
- 28.5" Working Height
- Accepts 4" O.C. Splash Mount Faucet

Now in 12" & 14" wide units!



Part Number	Faucet	LIST PRICE
BKUBS-1014HS-18S	N/A	\$418
BKUBS-1014HS-18-P-GS	BKF-W2-6-G	\$471
BKUBS-1014HS12-18S	N/A	\$406
BKUBS-1014HS12-18S-P-G	BKF-W2-6-G	\$457

#### BKUB-SS18 Single Removable Side Splash

! Also See Pg. 35

LIST PRICE  
**\$31.00**

- T-304 16 ga Stainless Steel
- Fits BK Resources 18" Slim Line Underbar Equipment
- 4 Self-Tapping Screws
- Caulking

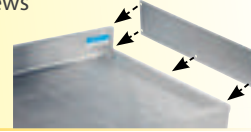

BKDR-2

BK-OT-15075

BKF-W2-10-G

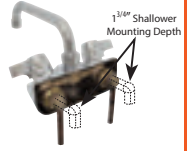

#### BKUBD-C1818S Corner Drainboard

- Includes BKDR-15CP drain
- SS Legs and Bracing
- Adjustable High Impact Corrosion Resistant Bullet Feet



Part Number	Size: (l x w)	LIST PRICE
BKUBD-C1818S	18" x 18"	\$565

#### BKUBW - Slim-Line Stainless Steel Underbar Sinks



- 18 ga T-304 Stainless Steel
- Integrally Welded Bowls 10" (l) x 14" (w) x 10" (d)
- Stamped and Pitched Drainboards
- SS Legs and Bracing
- Adjustable High Impact Corrosion Resistant Bullet Feet
- Includes:
  - BKF-W2-10-G Faucet
  - BKDR-2 Basket Drains
  - BK-OT-15075 7" Overflow Tubes



All-in-One

#### Slim-Line Underbar Dump Sink with Integral Towel & Soap Dispenser



- T-304 18 ga Stainless Steel
- SS Legs and Bracing
- Adjustable High Impact Corrosion Resistant Bullet Feet
- Includes Strainer Basket, BK-UCSD-1 Soap Dispenser, Basket Drain (BKDR-2)
- Overall Dimensions: BKUBS-1012HST-518S (15"W x 18"D), BKUBS-1012HST-218S (12"W x 18"D)

Part Number	Faucet	LIST PRICE
BKUBS-1012HST-518S	N/A	\$790
BKUBS-1012HST-518S-P-G	BKF-W2-3G-G	\$859
BKUBS-1012HST-218S	N/A	\$780
BKUBS-1012HST-218S-P-G	BKF-W2-3G-G	\$844



#### BKUBD - Slim-Line Stainless Steel Drainboards



- T-304 18 ga Stainless Steel
- SS Legs and Bracing
- Adjustable High Impact Corrosion Resistant Bullet Feet
- Stamped Drainboards
- 32 1/2" Standard Height
- Includes Drain (BKDR-15CP)

Part Number	Size: (l x w)	LIST PRICE
BKUBD-12-18S	12" x 18"	\$332
BKUBD-18-18S	18" x 18"	\$396
BKUBD-24-18S	24" x 18"	\$433
BKUBD-30-18S	30" x 18"	\$488
BKUBD-36-18S	36" x 18"	\$531
BKUBD-48-18S	48" x 18"	\$587

Part #	Length	# of Bowls	Drainboard Size	Faucet Holes	Sets of	LIST
						PRICE
BKUBW-224S	24"	2	N/A	1		\$721
BKUBW-336S	36"	3	N/A	1		\$824
BKUBW-448S	48"	4	N/A	2		\$927
BKUBW-236LS	36"	2	(1) L - 12 3/4"	1		\$783
BKUBW-236RS	36"	2	(1) R - 12 3/4"	1		\$783
BKUBW-248LS	48"	2	(1) L - 24"	1		\$838
BKUBW-248RS	48"	2	(1) R - 24"	1		\$838
BKUBW-248TS	48"	2	(2) - 13 3/16"	1		\$851
BKUBW-348LS	48"	3	(1) L - 13 5/8"	1		\$976
BKUBW-348RS	48"	3	(1) R - 13 5/8"	1		\$976
BKUBW-360LS	60"	3	(1) L - 24 1/8"	1		\$1,032
BKUBW-360RS	60"	3	(1) R - 24 1/8"	1		\$1,032
BKUBW-360TS	60"	3	(2) - 13 1/2"	1		\$1,044
BKUBW-372TS	72"	3	(2) - 19"	1		\$1,112
BKUBW-472TS	72"	4	(2) - 13 3/4"	2		\$1,261
BKUBW-384TS	84"	3	(2) - 25"	1		\$1,135
BKUBW-484TS	84"	4	(2) - 19"	2		\$1,318
BKUBW-396TS	96"	3	(2) - 31"	1		\$1,215
BKUBW-496TS	96"	4	(2) - 25"	2		\$1,399



**BK-MIB - Stainless Steel Mobile Ice Bin**



- 3" Casters With Toe Activated Brake
- Removable Bottom Tray
- Drain Ball Valve In Rear of Unit

Part Number	Unit Size (l x w x h)	Ice Bin Dim. (l x w x d)	Ice Bin Capacity	LIST PRICE
BK-MIB-2422	24" x 22" x 29"	21 <sup>7</sup> / <sub>8</sub> " x 19 <sup>11</sup> / <sub>16</sub> " x 15 <sup>15</sup> / <sub>16</sub> "	200 lbs.	\$1,426
BK-MIB-2411	24" x 11" x 29"	21 <sup>7</sup> / <sub>8</sub> " x 8 <sup>11</sup> / <sub>16</sub> " x 15 <sup>15</sup> / <sub>16</sub> "	90 lbs.	\$1,197

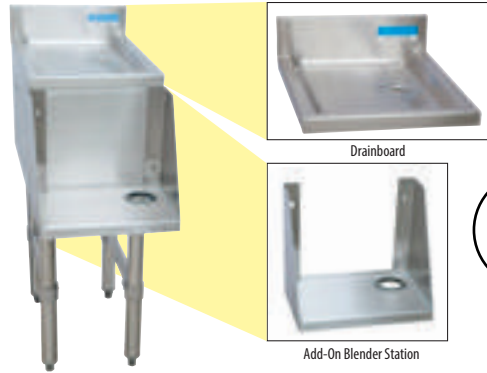

All-in-One

**BKUBDMX - Mixing Station**

- T-304 18 ga Stainless Steel
- Drainboard with Add-On Blender Station Shelf
- Available in 18" and 21" Depth

Part Number	Drainboard Part #	Depth	LIST PRICE
BKUBDMX-12-18S	BKUBD-12-18S	18"	\$452
BKUBDMX-12-21S	BKUBD-12-21S	21"	\$462
BKUBDMX-18-18S	BKUBD-18-18S	18"	\$551
BKUBDMX-18-21S	BKUBD-18-21S	21"	\$563



Other sizes available. See pg. 37

BKHS-D-SS-SKTS  
Faucet Sold Separately

**BKHS-D-SS-SKTS**  
**9"x 9" Space Saving Deck Mount Hand Sink w/ Integrated Towel Dispenser**



**AOBS**  
**Add-On Blender Station**

- T-304 18 ga Stainless Steel
- 8" Deep Platform

Part #	Shelf Size	LIST PRICE
AOBS-12	12"	\$120
AOBS-18	18"	\$155



**BKUBGC-24**  
**24" x 21" Stainless Steel Glass Rack**



- T-304 18 ga Stainless Steel
- Stainless Steel Legs
- Holds (3) 20" x 20" Glass Racks
- 24" O.A. (w), 30" Work (h), 32<sup>1</sup>/<sub>2</sub>" O.A.(h)
- Includes BKDR-15CP Drain



BKUBGC-242

Part Number	# of Shelves	LIST PRICE
BKUBGC-241	1	\$639
BKUBGC-242	2	\$639



BK-IBBH



BK-IBBH-18

**BK-IBBH / BK-IBBH-18**  
**Bottle Well Holder**

- Keeps Bottles Cold w/o Contacting Ice
- Fits Ice Bins with & without Cold Plate



Part Number	Front to Back	LIST PRICE
BK-IBBH-18	18"	\$29
BK-IBBH	21"	\$36

**BKUBSR**  
**Stainless Steel Speed Rail**

- Keyhole Mounting
- T-304 18 ga Stainless Steel
- Single or Double



Single Part #	Length	LIST PRICE	Double Part #	Length	LIST PRICE
BKUBSR-24	24"	\$52	BKUBSR-2-24	24"	\$124
BKUBSR-30	30"	\$64	BKUBSR-2-30	30"	\$129
BKUBSR-36	36"	\$68	BKUBSR-2-36	36"	\$139
BKUBSR-48	48"	\$70	BKUBSR-2-48	48"	\$144



POS Station - Spice Rack - Tubular Shelf - Slant Rack Shelf - Microwave Shelves



Cords run through holes for less clutter and easier access to outlets

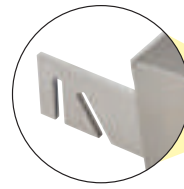

Attaches to any BK Resources Pot Rack. Designed to be used with the APR - Adjustable Table Mount Pot Rack (See pg. 65)



**BKDC-2124-2H**  
**Point of Sale Work Station**

LIST PRICE  
**\$875.00**

- T-304 18 ga Stainless Steel
- Hole in top and back to run cords
- Fixed Shelf
- Stainless Steel Legs

**BK-ICT**  
**Condiment/Spice Rack**

LIST PRICE  
**\$124.00**

- T-304 18 ga Stainless Steel
- 18.5" Overall Length
- Various Uses: Holds Spice Containers, Condiment Bins and many more uses



**BKMWS**  
**Microwave Shelves**



- T-304 16 & 18 ga Stainless Steel
- 1 1/2" Mounting Back Lip
- 15" Angle Supports
- Mounting Template Included
- Solid Base

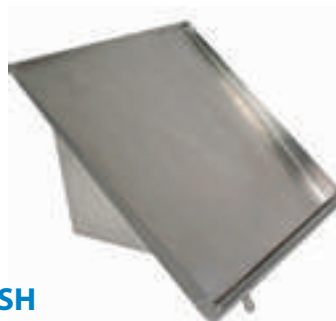

**BK-SSH**  
**Stainless Steel Slant Rack Shelf**



- T-304 18 ga Stainless Steel
- Mounting Brackets Included
- S/S Weep Accepts 1" Nylon Tubing (Nylon Tubing Not Included)



**BK-TSH**  
**Stainless Steel Tubular Dish Shelf**



- T-304 18 ga Stainless Steel
- 11 1/4" Tall
- 18 3/4" Deep
- 1 5/8" O.D. Stainless Tubing
- Slotted Mounting Holes For Easier Mounting

Part Number	Gauge	Size: (l x w)	LIST PRICE
BKMWS-2024	16 ga.	24" x 20"	\$206
BKMWS-2030	16 ga.	30" x 20"	\$241
BKMWS-2424	18 ga.	24" x 24"	\$187
BKMWS-1824	18 ga.	24" x 18"	\$130

Part Number	Size: (l x h)	LIST PRICE
BK-SSH-21	21" x 22"	\$181
BK-SSH-42	42" x 22"	\$241
BK-SSH-63	63" x 22"	\$318

Part Number	Length	LIST PRICE
BK-TSH-22	22"	\$189
BK-TSH-42	42"	\$243
BK-TSH-63	63"	\$300

**T-304 PREMIUM Stainless Steel**



**BKWS**  
**T-304 Premium Stainless Steel Wall Shelf**

- T-304 18 ga. Stainless Steel
- Available in Depths of 12" and 16"
- 1 1/2" Turn Up
- 12" (d) Shelves Have 8" Angle Supports
- 16" (d) Shelves Have 11 1/2" Angle Supports





**BKWS**  
**T-304 Premium Stainless Steel Wall Shelf w/ Pot Rack**

- Includes 1 double prong pot hook (BKSSDPH) for every 12" of pot rack
- T-304 Stainless Steel Flat Bar
- 18 ga. T-304 Stainless Steel Shelf



12" Depth	LIST PRICE	Width:	# of Support Brackets
BKWS-1224	\$92	24"	2
BKWS-1230	\$98	30"	2
BKWS-1236	\$104	36"	2
BKWS-1248	\$141	48"	2
BKWS-1260	\$168	60"	2
BKWS-1272	\$189	72"	3
BKWS-1284	\$209	84"	3
BKWS-1296	\$229	96"	3 

12" Depth	LIST PRICE	Width:	# of Support Brackets	# of Pot Hooks
BKWS-1224-PR	\$182	24"	2	2
BKWS-1230-PR	\$193	30"	2	2
BKWS-1236-PR	\$204	36"	2	3
BKWS-1248-PR	\$251	48"	2	4
BKWS-1260-PR	\$288	60"	2	5
BKWS-1272-PR	\$389	72"	3	6
BKWS-1284-PR	\$419	84"	3	7
BKWS-1296-PR	\$449	96"	3	8 

16" Depth	LIST PRICE	Width:	# of Support Brackets
BKWS-1624	\$108	24"	2
BKWS-1630	\$125	30"	2
BKWS-1636	\$141	36"	2
BKWS-1648	\$162	48"	2
BKWS-1660	\$193	60"	2
BKWS-1672	\$229	72"	3
BKWS-1684	\$258	84"	3
BKWS-1696	\$287	96"	3 

16" Depth	LIST PRICE	Width:	# of Support Brackets	# of Pot Hooks
BKWS-1624-PR	\$198	24"	2	2
BKWS-1630-PR	\$220	30"	2	2
BKWS-1636-PR	\$241	36"	2	3
BKWS-1648-PR	\$272	48"	2	4
BKWS-1660-PR	\$313	60"	2	5
BKWS-1672-PR	\$429	72"	3	6
BKWS-1684-PR	\$468	84"	3	7
BKWS-1696-PR	\$507	96"	3	8 

T-430 ECONOMY Stainless Steel Wall Shelves





**BKWSE**

**T-430 Economy Stainless Steel Wall Shelf**

- Available in Depths of 12" and 16"
- 12" (d) Shelves Have 8" Angle Supports
- 16" (d) Shelves Have 11 1/2" Angle Supports
- T-430 18 ga. Stainless Steel
- 1 1/2" Turn Up



12" Depth	LIST PRICE	Width:	# of Support Brackets
BKWSE-1224	\$79	24"	2
BKWSE-1232	\$85	32"	2
BKWSE-1236	\$98	36"	2
BKWSE-1248	\$121	48"	2
BKWSE-1260	\$146	60"	2
BKWSE-1272	\$168	72"	3
BKWSE-1284	\$192	84"	3
BKWSE-1296	\$216	96"	3 

16" Depth	LIST PRICE	Width:	# of Support Brackets
BKWSE-1624	\$83	24"	2
BKWSE-1632	\$104	32"	2
BKWSE-1636	\$127	36"	2
BKWSE-1648	\$137	48"	2
BKWSE-1660	\$185	60"	2
BKWSE-1672	\$208	72"	3
BKWSE-1684	\$243	84"	3
BKWSE-1696	\$277	96"	3 

**BKWSE**

**T-430 Economy Stainless Steel Wall Shelf w/ Pot Rack**

- Includes 1 double prong pot hook (BKSSDPH) for every 12" of pot rack
- T-304 Stainless Steel Flat Bar
- 18 ga. T-430 Stainless Steel Shelf



12" Depth	LIST PRICE	Width:	# of Support Brackets	# of Pot Hooks
BKWSE-1224-PR	\$169	24"	2	2
BKWSE-1236-PR	\$198	36"	2	3
BKWSE-1248-PR	\$231	48"	2	4
BKWSE-1260-PR	\$266	60"	2	5
BKWSE-1272-PR	\$368	72"	3	6
BKWSE-1284-PR	\$402	84"	3	7
BKWSE-1296-PR	\$436	96"	3	8 



16" Depth	LIST PRICE	Width:	# of Support Brackets	# of Pot Hooks
BKWSE-1624-PR	\$173	24"	2	2
BKWSE-1636-PR	\$227	36"	2	3
BKWSE-1648-PR	\$247	48"	2	4
BKWSE-1660-PR	\$305	60"	2	5
BKWSE-1672-PR	\$408	72"	3	6
BKWSE-1684-PR	\$453	84"	3	7
BKWSE-1696-PR	\$497	96"	3	8 

# NEXT GENERATION SHELVING

## BK1-SNGWS - Single Flange Next Generation Shelves

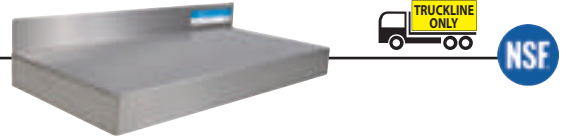
- Flat solid surfaces throughout
- Easy clean-ability for health codes
- T-304 18 ga. stainless steel
- Typical food service configuration
- Top flange for added mounting support





Part Number	Size: (l x w)	# of Support Brackets	LIST PRICE
BK1-SNGWS-12-2	24" x 12"	2	\$171
BK1-SNGWS-12-3	36" x 12"	2	\$185
BK1-SNGWS-12-4	48" x 12"	3	\$220
BK1-SNGWS-12-5	60" x 12"	3	\$258
BK1-SNGWS-12-6	72" x 12"	4	\$308 
BK1-SNGWS-12-8	96" x 12"	5	\$366 

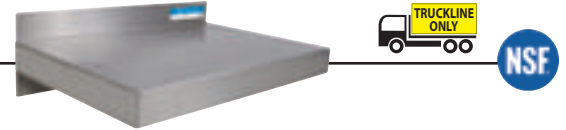

## BK2-SNGWS - Double Flange Next Generation Shelves

- Heavy duty food service configuration
- Top flange for added mounting support
- T-304 18 ga. stainless steel
- Bottom flange for added strength
- Flat solid surfaces throughout



Part Number	Size: (l x w)	# of Support Brackets	LIST PRICE
BK2-SNGWS-16-2	24" x 16"	2	\$193
BK2-SNGWS-16-3	36" x 16"	2	\$214
BK2-SNGWS-16-4	48" x 16"	3	\$243
BK2-SNGWS-16-5	60" x 16"	3	\$295
BK2-SNGWS-16-6	72" x 16"	4	\$345 
BK2-SNGWS-16-8	96" x 16"	5	\$404 



## BK-NGPR - Next Generation Shelving Pot Racks

- Includes 1 double prong pot hook (BKSSDPH) for every 12" of pot rack
- 2" T-304 Stainless Steel Flat Bar
- Pot Rack does not come with Shelf

Part Number	Fits shelf size:	Pot Hooks	LIST PRICE
BK-NGPR-24	24"	2	\$110
BK-NGPR-36	36"	3	\$162
BK-NGPR-48	48"	4	\$208
BK-NGPR-60	60"	5	\$254
BK-NGPR-72	72"	6	\$304
BK-NGPR-96	96"	8	\$364



Wall Cabinets - Dish Cabinets - Glass Rack Dolly Carts



**BKWCH - Wall Cabinet w/ Hinged Doors**

- T-304 18 ga Stainless Steel
- 15" Deep
- Fixed Position Shelf - 11 5/8" from Bottom of Cabinet

Part Number	NSF	Size: (w x d x h)	LIST PRICE
BKWCH-1524	✓	24" x 15" x 32 1/2"	\$660
BKWCH-1530	✓	30" x 15" x 32 1/2"	\$707
BKWCH-1536	✓	36" x 15" x 32 1/2"	\$827
BKWCH-1548	✓	48" x 15" x 32 1/2"	\$905



**BKDC- Stainless Steel Dish Cabinet**

- T-304 18 ga Stainless Steel
- 1 5/8" x 6" Straight S/S Leg
- Legs Adjust 1" in Height
- Fixed Position Shelf
- 15" & 18" Depth Available

**15" Deep**

Part Number	NSF	Size: (l x w)	LIST PRICE
BKDC-1536	✓	36" x 15"	\$723
BKDC-1548	✓	48" x 15"	\$784
BKDC-1560	✓	60" x 15"	\$886
BKDC-1572	✓	72" x 15"	\$1,013

**18" Deep**

Part Number	NSF	Size: (l x w)	LIST PRICE
BKDC-1836	✓	36" x 18"	\$901
BKDC-1848	✓	48" x 18"	\$1,084
BKDC-1860	✓	60" x 18"	\$1,267
BKDC-1872	✓	72" x 18"	\$1,452



**BK-GRD-2  
Glass Rack Dolly  
Cart w/ Handle**

- Aluminum Construction
- Accommodates 19 3/4" x 19 3/4" Glass Racks
- 4" Swivel Casters
- Some Assembly Required

LIST PRICE  
**\$173.00**



**BK-GRD-1  
Glass Rack Dolly Cart**

- Aluminum Construction
- Accommodates 19 3/4" x 19 3/4" Glass Racks
- 3" Swivel Casters

LIST PRICE  
**\$173.00**

Front Load Bun Pan Racks



**BK-ABPR-1**  
Square Top  
Bun Pan Rack

NSF  
LIST PRICE  
\$206.00

- Stores 20 ea. 18 x 26 pans
- Ships Knocked Down
- 6065-T3 Aluminum Tubing
- Assembles Easily
- 5" Non-locking Swivel Casters
- 69" (h) x 26" (d) x 20-1/4" (w)



**BK-ABPR-2**  
Rounded Top  
Bun Pan Rack

NSF  
LIST PRICE  
\$229.00

- Stores 20 ea. 18 x 26 pans
- Ships Knocked Down
- 6065-T3 Aluminum
- Assembles Easily
- 5" Non-locking Swivel Casters
- 70" (h) x 26" (d) x 20-1/4" (w)



**BK-ABPRZ-1**  
Welded Nestable  
Bun Pan Rack

NSF  
LIST PRICE  
\$391.00

- Stores 20 ea. 18 x 26 pans
- Ships Welded Setup
- 6065-T3 Aluminum
- 5" Non-locking Swivel Casters
- 70-3/4" (h) x 26" (d) x 20-1/4" (w)



Side Load Bun Pan Racks



**BK-ABPR-1S**  
Square Top  
Bun Pan Rack

NSF  
LIST PRICE  
\$235.00

- Stores 20 ea. 18 x 26 pans
- Ships Knocked Down
- 6065-T3 Aluminum Tubing
- Assembles Easily
- 5" Non-locking Swivel Casters
- 69" (h) x 26" (d) x 20-1/4" (w)



**BK-ABPR-2S**  
Rounded Top  
Bun Pan Rack

NSF  
LIST PRICE  
\$254.00

- Stores 20 ea. 18 x 26 pans
- Ships Knocked Down
- 6065-T3 Aluminum
- Assembles Easily
- 5" Non-locking Swivel Casters
- 70" (h) x 26" (d) x 20-1/4" (w)



**BK-ABPRZ-1S**  
Welded Nestable  
Bun Pan Rack

NSF  
LIST PRICE  
\$391.00

- Stores 20 ea. 18 x 26 pans
- Ships Welded Setup
- 6065-T3 Aluminum
- 5" Non-locking Swivel Casters
- 70-3/4" (h) x 26" (d) x 20-1/4" (w)



Accessories



**BK-ABPR-CVR1**  
Plastic Bun Pan Rack Cover

LIST PRICE  
\$46.00

- Protect Your Products During Transport
- Heavy Duty Clear Plastic (for easy product identification)
- 3 Reinforced zippers
- Dimensions: 61" (h) x 26" (d) x 28" (w)



**BK-BPD-1**  
Welded Bun  
Pan Dolly

LIST PRICE  
\$248.00

- Aluminum Construction
- Accommodates 18" x 26" Sheet Pans
- 5" Swivel Casters
- 1,000 lbs. capacity

Utility Carts - Dry Storage Shelving Units

**BKC - Stainless Steel Utility Cart**



- BKC-1524-3S & BKC-1827-3S Includes: (4) 3 1/2" Swivel Casters, (2) w/ Brakes
- BKC-2133S-2H Includes: (2) 3 1/2" Swivel Casters, (2) Fixed Casters
- All Welded Construction



BKC-1524S-3S



BKC-2133S-2H

Part #	Shelf Size (l x w)	# of Shelves	Material	Weight Cap.	LIST PRICE
BKC-1524S-3S	24" x 15 1/2"	3	T-430 S/S	300 lbs.	\$255
BKC-1827S-3S	27" x 18"	3	T-430 S/S	300 lbs.	\$312
BKC-2133S-2H	33" x 21"	2	T-430 S/S	700 lbs.	\$676



All Shelving Units Include Adjustable Shelves



Shown with optional casters

**VS - Dry Storage Shelving Unit**

- 2, 3 & 4 shelf options
- Adjustable galvanized shelves and posts
- Adjustable bullet feet

Part #	Unit Size (l x w x h)	Shelves	LIST PRICE
VSU6-3124	31" x 24" x 72"	4	\$294
VSU6-4324	43" x 24" x 72"	4	\$342
VSU6-5524	55" x 24" x 72"	4	\$396
VSU6-6724	67" x 24" x 72"	4	\$450
VSU5-3124	31" x 24" x 60"	3	\$240
VSU5-4324	43" x 24" x 60"	3	\$276
VSU5-5524	55" x 24" x 60"	3	\$316
VSU5-6724	67" x 24" x 60"	3	\$356
VSU3-3124	31" x 24" x 38"	2	\$168
VSU3-4324	43" x 24" x 38"	2	\$192
VSU3-5524	55" x 24" x 38"	2	\$219
VSU3-6724	67" x 24" x 38"	2	\$246

**Create a Cart or Mobile Shelving Unit by Adding Casters!**



**For Caster Kits**

See Pg. 76 for more options.

**SS - Dry Storage Shelving Unit**

- 2, 3 & 4 shelf options
- Adjustable Stainless Steel shelves and posts
- Adjustable bullet feet

Part #	Unit Size (l x w x h)	Shelves	LIST PRICE
SSU6-3124	31" x 24" x 72"	4	\$569
SSU6-4324	43" x 24" x 72"	4	\$676
SSU6-5524	55" x 24" x 72"	4	\$802
SSU6-6724	67" x 24" x 72"	4	\$884
SSU5-3124	31" x 24" x 60"	3	\$460
SSU5-4324	43" x 24" x 60"	3	\$540
SSU5-5524	55" x 24" x 60"	3	\$635
SSU5-6724	67" x 24" x 60"	3	\$696
SSU3-3124	31" x 24" x 38"	2	\$311
SSU3-4324	43" x 24" x 38"	2	\$365
SSU3-5524	55" x 24" x 38"	2	\$427
SSU3-6724	67" x 24" x 38"	2	\$486



**BK-WPR1 - Single Bar Pot Rack**



- Includes 1 double prong pot hook (BKSSDPH) for every 12" of pot rack
- 2" T-304 Stainless Steel Flat Bar
- 12" Deep



**BK-WPR2 - Double Bar Pot Rack**



- Includes 1 double prong pot hook (BKSSDPH) for every 12" of pot rack
- 2" T-304 Stainless Steel Flat Bar
- Top Bar 12" (d), Bottom Bar 6" (d), 16" O.A (h)



Part #	Length	Pot Hooks	LIST PRICE
BK-WPR1-48	48"	4	\$158
BK-WPR1-60	60"	5	\$166
BK-WPR1-72	72"	6	\$191

Part #	Length	Pot Hooks	LIST PRICE
BK-WPR2-48	48"	8	\$368
BK-WPR2-60	60"	10	\$414
BK-WPR2-72	72"	12	\$462

**Pot Hooks**

- T-304 Stainless Steel
- Single & Double Pot Hooks Available



Part Number	Hook Type	LIST PRICE
<b>Stainless Pot Hooks</b>		
BKSSDPH	Double	\$2.00
BKSSPH	Single	\$2.00

**BK Resources' NEW Pot Racks**



**BK-ICT - Condiment/Spice Rack**

See pg. 58 for details



**APR - Adjustable Table Mount Pot Rack**

- 1 hook per every 12" of pot rack
- Mounts directly to table with self-tapping screws

Part #	Length	LIST PRICE
APR-36	36"	\$187
APR-48	48"	\$208
APR-60	60"	\$239
APR-72	72"	\$270

**APR-BAR - Single Bar Add On**

- Add an extra bar to your pot rack
- 1 hook per every 12" of pot rack

Part #	Length	LIST PRICE
APR-36BAR	36"	\$187
APR-48BAR	48"	\$208
APR-60BAR	60"	\$239
APR-72BAR	72"	\$270

**BK-CM - Ceiling Mount Pot Rack**

- T-304 Stainless Steel
- Includes Pot Hooks
- Includes 24" Chain & S-Hooks
- Ships KD

Part #	l x w	Pot Hooks	LIST PRICE
BK-CM36PR	28" x 20"	18	\$577
BK-CM48PR	40" x 20"	24	\$640
BK-CM60PR	52" x 20"	30	\$697
BK-CM72PR	64" x 20"	36	\$759
BK-CM96PR	88" x 20"	48	\$978





## Overshelves - Stackable & Non-Stackable Aluminum Dunnage Racks



### BK-OSD / OSS - Stainless Steel Overshelves



BK-OSD-1248  
Shown

Double Overshelves 31 1/4" (h)

- T-304 18 ga Stainless Steel
- Adjustable Lower Shelves

- Mounts directly on table with included self-tapping screws

- Shipped Knocked Down
- 96" has 3 Upright Supports

#### Double Over Shelves

Length	12" Width Part Number	LIST PRICE	18" Width Part Number	LIST PRICE
36"	BK-OSD-1236	\$264	BK-OSD-1836	\$349
48"	BK-OSD-1248	\$291	BK-OSD-1848	\$408
60"	BK-OSD-1260	\$316	BK-OSD-1860	\$453
72"	BK-OSD-1272	\$339	BK-OSD-1872	\$516
96"	BK-OSD-1296	\$412	BK-OSD-1896	\$661

#### Single Over Shelves



BK-OSS-1248  
Shown

Single Overshelves 18" (h)

Length	12" Width Part Number	LIST PRICE	18" Width Part Number	LIST PRICE
36"	BK-OSS-1236	\$196	BK-OSS-1836	\$277
48"	BK-OSS-1248	\$218	BK-OSS-1848	\$312
60"	BK-OSS-1260	\$241	BK-OSS-1860	\$345
72"	BK-OSS-1272	\$266	BK-OSS-1872	\$391
96"	BK-OSS-1296	\$349	BK-OSS-1896	\$495

### BK-ADR - Dunnage Rack

- 1 1/2" Square Tubing
- Aluminum Tubing

- 12" O.A. Height
- If Shipping UPS, will go at Oversized Rate



Part #	Size: (l x w)	Capacity	LIST PRICE
BK-ADR-3620-12	36" X 20"	3,000 lbs	\$81
BK-ADR-3624-12	36" X 24"	3,000 lbs	\$92
BK-ADR-4820-12	48" X 20"	2,000 lbs	\$92
BK-ADR-4824-12	48" X 24"	2,000 lbs	\$104
BK-ADR-6020-12	60" X 20"	1,500 lbs	\$104
BK-ADR-6024-12	60" X 24"	1,500 lbs	\$127



### BK-ST-ADR - Stackable Dunnage Rack

- 1 1/2" Square Tubing
- Aluminum Tubing

- Vertical "L" Shaped Legs for Stacking
- 12" O.A. Height



Part #	Size: (l x w)	Capacity	LIST PRICE
BK-ST-ADR-2420-12	24" X 20"	1,500 lbs	\$72
BK-ST-ADR-3620-12	36" X 20"	1,500 lbs	\$81
BK-ST-ADR-3624-12	36" X 24"	1,500 lbs	\$92
BK-ST-ADR-4820-12	48" X 20"	1,000 lbs	\$92
BK-ST-ADR-4824-12	48" X 24"	1,000 lbs	\$104
BK-ST-ADR-6020-12	60" X 20"	750 lbs	\$104
BK-ST-ADR-6024-12	60" X 24"	750 lbs	\$127





**Additional Accessories**

- S/S Drawers Pg. 70 & 86
- S/S Overshelves Pg. 66
- Pot Rack Pg. 65

**W/ GALVANIZED LEGS & UNDERSHELF**

T-430

**VTT - Stainless Steel Work Table with Galvanized Leg & Undershef**

- T-430 18 ga. Stainless Steel Top
- 1 5/8" Galvanized Legs & Adjustable Undershef
- Top Reinforced with (2) 5" "C" Channels
- Adjustable High Impact Corrosion Resistant Feet
- 96" & 84" Tables Have 6 Legs
- 32 1/2" Height



Size: (l x w)	T-430 S/S Flat Table	T-430 S/S Riser Table	LIST PRICE	T-430 S/S 5" Riser Table	LIST PRICE
24" X 18"	VTT-1824	VTTR-1824	\$175	-	-
30" X 18"	VTT-1830	VTTR-1830	\$182	-	-
36" X 18"	VTT-1836	VTTR-1836	\$196	-	-
48" X 18"	VTT-1848	VTTR-1848	\$218	-	-
60" X 18"	VTT-1860	VTTR-1860	\$254	-	-
72" X 18"	VTT-1872	VTTR-1872	\$300	-	-
84" X 18"	VTT-1884	VTTR-1884	\$338	-	-
96" X 18"	VTT-1896	VTTR-1896	\$358	-	-
24" X 24"	VTT-2424	VTTR-2424	\$168	VTTR5-2424	\$218
30" X 24"	VTT-3024	VTTR-3024	\$185	VTTR5-3024	\$254
36" X 24"	VTT-3624	VTTR-3624	\$214	VTTR5-3624	\$277
48" X 24"	VTT-4824	VTTR-4824	\$241	VTTR5-4824	\$322
60" X 24"	VTT-6024	VTTR-6024	\$285	VTTR5-6024	\$335
72" X 24"	VTT-7224	VTTR-7224	\$312	VTTR5-7224	\$414
84" X 24"	VTT-8424	VTTR-8424	\$345	VTTR5-8424	\$462
96" X 24"	VTT-9624	VTTR-9624	\$404	VTTR5-9624	\$508
30" X 30"	VTT-3030	VTTR-3030	\$208	VTTR5-3030	\$264
36" X 30"	VTT-3630	VTTR-3630	\$231	VTTR5-3630	\$287
48" X 30"	VTT-4830	VTTR-4830	\$260	VTTR5-4830	\$335
60" X 30"	VTT-6030	VTTR-6030	\$297	VTTR5-6030	\$368
72" X 30"	VTT-7230	VTTR-7230	\$327	VTTR5-7230	\$437
84" X 30"	VTT-8430	VTTR-8430	\$391	VTTR5-8430	\$499
96" X 30"	VTT-9630	VTTR-9630	\$437	VTTR5-9630	\$553

**VTS - Galvanized Undershef**

- Each Corner Brace includes 2 Set Screws for Maximum Stability
- Specifically Designed to Fit BK Resources Tables

Additional Galvanized Undershef	Fits Table Size: (l x w)	LIST PRICE
VTS-1824	24" X 18"	\$52
VTS-1830	30" X 18"	\$57
VTS-1836	36" X 18"	\$62
VTS-1848	48" X 18"	\$68
VTS-1860	60" X 18"	\$73
VTS-1872	72" X 18"	\$83
VTS-1884	84" X 18"	\$94
VTS-1896	96" X 18"	\$104
VTS-2424	24" X 24"	\$37
VTS-3024	30" X 24"	\$48
VTS-3624	36" X 24"	\$58
VTS-4824	48" X 24"	\$64
VTS-6024	60" X 24"	\$85
VTS-7224	72" X 24"	\$98
VTS-8424	84" X 24"	\$133
VTS-9624	96" X 24"	\$133
VTS-3030	30" X 30"	\$60
VTS-3630	36" X 30"	\$73
VTS-4830	48" X 30"	\$98
VTS-6030	60" X 30"	\$123
VTS-7230	72" X 30"	\$146
VTS-8430	84" X 30"	\$181
VTS-9630	96" X 30"	\$193

## T-430 Stainless Steel Work Tables



# T-430

## W/ STAINLESS STEEL LEGS & UNDERSHELF

### SVT - Stainless Steel Work Table with S/S Legs & Undershelf

- T-430 18 ga. Stainless Steel Top
- 1 5/8" Stainless Steel Legs & Adjustable Undershelf
- S/S Over Plastic Feet
- Top Reinforced with (2) 5" "C" Channels
- 84" & 96" Have 6 Legs
- 32 1/2" Height



Size: (l x w)	T-430 S/S Flat Table	T-430 S/S Riser Table	LIST PRICE	T-430 S/S 5" Riser Table	LIST PRICE
24" X 18"	SVT-1824	SVTR-1824	\$275	-	-
30" X 18"	SVT-1830	SVTR-1830	\$300	-	-
36" X 18"	SVT-1836	SVTR-1836	\$307	-	-
48" X 18"	SVT-1848	SVTR-1848	\$348	-	-
60" X 18"	SVT-1860	SVTR-1860	\$395	-	-
72" X 18"	SVT-1872	SVTR-1872	\$437	-	-
84" X 18"	SVT-1884	SVTR-1884	\$509	-	-
96" X 18"	SVT-1896	SVTR-1896	\$588	-	-
24" X 24"	SVT-2424	SVTR-2424	\$335	SVTR5-2424	\$427
30" X 24"	SVT-3024	SVTR-3024	\$358	SVTR5-3024	\$451
36" X 24"	SVT-3624	SVTR-3624	\$368	SVTR5-3624	\$462
48" X 24"	SVT-4824	SVTR-4824	\$404	SVTR5-4824	\$497
60" X 24"	SVT-6024	SVTR-6024	\$449	SVTR5-6024	\$543
72" X 24"	SVT-7224	SVTR-7224	\$485	SVTR5-7224	\$578
84" X 24"	SVT-8424	SVTR-8424	\$546	-	-
96" X 24"	SVT-9624	SVTR-9624	\$622	SVTR5-9624	\$705
30" X 30"	SVT-3030	SVTR-3030	\$358	SVTR5-3030	\$451
36" X 30"	SVT-3630	SVTR-3630	\$381	SVTR5-3630	\$474
48" X 30"	SVT-4830	SVTR-4830	\$414	SVTR5-4830	\$508
60" X 30"	SVT-6030	SVTR-6030	\$508	SVTR5-6030	\$601
72" X 30"	SVT-7230	SVTR-7230	\$576	SVTR5-7230	\$670
84" X 30"	SVT-8430	SVTR-8430	\$665	-	-
96" X 30"	SVT-9630	SVTR-9630	\$759	SVTR5-9630	\$853

### SVTS - Stainless Steel Undershelf

- Each Corner Brace includes 2 Set Screws for Maximum Stability
- Specifically Designed to Fit BK Resources Tables

Additional Stainless Undershelf	Fits Table Size: (l x w)	LIST PRICE
SVTS-1824	24" x 18"	\$94
SVTS-1830	30" x 18"	\$99
SVTS-1836	36" x 18"	\$104
SVTS-1848	48" x 18"	\$114
SVTS-1860	60" x 18"	\$130
SVTS-1872	72" x 18"	\$146
SVTS-1896	96" x 18"	\$192
SVTS-2424	24" x 24"	\$78
SVTS-3024	30" x 24"	\$86
SVTS-3624	36" x 24"	\$94
SVTS-4824	48" x 24"	\$123
SVTS-6024	60" x 24"	\$146
SVTS-7224	72" x 24"	\$164
SVTS-9624	96" x 24"	\$216
SVTS-3030	30" x 30"	\$110
SVTS-3630	36" x 30"	\$125
SVTS-4830	48" x 30"	\$155
SVTS-6030	60" x 30"	\$197
SVTS-7230	72" x 30"	\$228
SVTS-9630	96" x 30"	\$311

## Table Accessories

See More Details on Pg. 72



W/ GALVANIZED LEGS

T-430

VTT0B - Open Base Stainless Steel Work Table with Galvanized Legs

- T-430 18 ga. Stainless Steel
- 1 5/8" Galvanized Legs & Bracing
- 84" & 96" Tables Have 6 Legs
- Ships KD

- 32 1/2" Height
- Adjustable Impact Corrosion Resistant Feet



Size: (l x w)	T-430 S/S Flat Table	T-430 S/S Riser Table	LIST PRICE	T-430 S/S 5" Riser Table	LIST PRICE
24" X 18"	VTT0B-1824	VTTROB-1824	\$302	-	-
30" X 18"	VTT0B-1830	VTTROB-1830	\$307	-	-
36" X 18"	VTT0B-1836	VTTROB-1836	\$317	-	-
48" X 18"	VTT0B-1848	VTTROB-1848	\$348	-	-
60" X 18"	VTT0B-1860	VTTROB-1860	\$374	-	-
72" X 18"	VTT0B-1872	VTTROB-1872	\$385	-	-
84" X 18"	VTT0B-1884	VTTROB-1884	\$432	-	-
96" X 18"	VTT0B-1896	VTTROB-1896	\$463	-	-
24" X 24"	VTT0B-2424	VTTROB-2424	\$312	VTT50B-2424	\$354
30" X 24"	VTT0B-3024	VTTROB-3024	\$317	VTT50B-3024	\$359
36" X 24"	VTT0B-3624	VTTROB-3624	\$328	VTT50B-3624	\$380
48" X 24"	VTT0B-4824	VTTROB-4824	\$359	VTT50B-4824	\$442
60" X 24"	VTT0B-6024	VTTROB-6024	\$385	VTT50B-6024	\$447
72" X 24"	VTT0B-7224	VTTROB-7224	\$395	VTT50B-7224	\$494
84" X 24"	VTT0B-8424	VTTROB-8424	\$442	VTT50B-8424	\$541
96" X 24"	VTT0B-9624	VTTROB-9624	\$473	VTT50B-9624	\$577
30" X 30"	VTT0B-3030	VTTROB-3030	\$359	VTT50B-3030	\$416
36" X 30"	VTT0B-3630	VTTROB-3630	\$367	VTT50B-3630	\$426
48" X 30"	VTT0B-4830	VTTROB-4830	\$400	VTT50B-4830	\$452
60" X 30"	VTT0B-6030	VTTROB-6030	\$432	VTT50B-6030	\$504
72" X 30"	VTT0B-7230	VTTROB-7230	\$473	VTT50B-7230	\$551
84" X 30"	VTT0B-8430	VTTROB-8430	\$520	VTT50B-8430	\$624
96" X 30"	VTT0B-9630	VTTROB-9630	\$546	VTT50B-9630	\$655
96" x 36"	VTT0B-9636		\$936		

## Open Base Work Tables

### Additional Accessories

- S/S Drawers Pg. 74 & 86
- S/S Overshelves Pg. 66
- Casters Pg. 76-80



### For Caster Kits

⚠ See Pg. 76 for more options.



Available in 4 & 6 Pc. Sets

# T-430

## W/ STAINLESS STEEL LEGS

### SVTOB - Open Base All Stainless Work Table

- T-430 18 ga. Stainless Steel
- S/S Legs & Bracing
- 84" & 96" Tables Have 6 Legs
- Ships KD

- 32<sup>1/2</sup>" Height
- Stainless Steel over Plastic Feet



Size: (l x w)	T-430 S/S Flat Table	T-430 S/S Riser Table	LIST PRICE	T-430 S/S 5" Riser Table	LIST PRICE
24" X 18"	SVTOB-1824	SVTROB-1824	\$468	-	-
30" X 18"	SVTOB-1830	SVTROB-1830	\$478	-	-
36" X 18"	SVTOB-1836	SVTROB-1836	\$494	-	-
48" X 18"	SVTOB-1848	SVTROB-1848	\$541	-	-
60" X 18"	SVTOB-1860	SVTROB-1860	\$582	-	-
72" X 18"	SVTOB-1872	SVTROB-1872	\$598	-	-
84" X 18"	SVTOB-1884	SVTROB-1884	\$671	-	-
96" X 18"	SVTOB-1896	SVTROB-1896	\$723	-	-
24" X 24"	SVTOB-2424	SVTROB-2424	\$484	SVTR50B-2424	\$551
30" X 24"	SVTOB-3024	SVTROB-3024	\$494	SVTR50B-3024	\$562
36" X 24"	SVTOB-3624	SVTROB-3624	\$510	SVTR50B-3624	\$593
48" X 24"	SVTOB-4824	SVTROB-4824	\$562	SVTR50B-4824	\$692
60" X 24"	SVTOB-6024	SVTROB-6024	\$598	SVTR50B-6024	\$697
72" X 24"	SVTOB-7224	SVTROB-7224	\$619	SVTR50B-7224	\$770
84" X 24"	SVTOB-8424	SVTROB-8424	\$692	SVTR50B-8424	\$848
96" X 24"	SVTOB-9624	SVTROB-9624	\$738	SVTR50B-9624	\$900
30" X 30"	SVTOB-3030	SVTROB-3030	\$562	SVTR50B-3030	\$650
36" X 30"	SVTOB-3630	SVTROB-3630	\$572	SVTR50B-3630	\$666
48" X 30"	SVTOB-4830	SVTROB-4830	\$605	SVTR50B-4830	\$707
60" X 30"	SVTOB-6030	SVTROB-6030	\$639	SVTR50B-6030	\$790
72" X 30"	SVTOB-7230	SVTROB-7230	\$659	SVTR50B-7230	\$863
84" X 30"	SVTOB-8430	SVTROB-8430	\$740	SVTR50B-8430	\$980
96" X 30"	SVTOB-9630	SVTROB-9630	\$789	SVTR50B-9630	\$1,029



WST-4830  
Shown

**For Caster Kits**  

 See Pg. 76 for more options.



WSTR-4830  
Shown



WSTR5-4830  
Shown

T-304

STAINLESS STEEL WORK TABLES

WST/WSTR - T-304 Stainless Steel Work Table with Stainless Steel Legs & Undershelf

- T-304 18 ga. Stainless Steel Top
- 1<sup>5/8</sup>" Stainless Steel Legs & Adjustable Undershelf
- 84" & 96" Tables Have 6 Legs

- Stainless Steel over Plastic Feet
- Top Reinforced with (2) 5" "C" Channels
- 32<sup>1/2</sup>" Height



Size: (l x w)	T-304 S/S Flat Table	T-304 S/S Riser Table	LIST PRICE	T-304 S/S 5" Riser Table	LIST PRICE
36" X 30"	WST-3630	WSTR-3630	\$447	WSTR5-3630	\$477
48" X 30"	WST-4830	WSTR-4830	\$494	WSTR5-4830	\$550
60" X 30"	WST-6030	WSTR-6030	\$581	WSTR5-6030	\$661
72" X 30"	WST-7230	WSTR-7230	\$661	WSTR5-7230	\$697
96" X 30"	WST-9630	WSTR-9630	\$874	WSTR5-9630	\$915

WTT/WTTR - T-304 Stainless Steel Work Table with Galvanized Legs & Undershelf

- T-304 18 ga. Stainless Steel Top
- 1<sup>5/8</sup>" Galvanized Legs & Adjustable Undershelf
- 84" & 96" Tables Have 6 Legs

- Adjustable High Impact Corrosion Resistant Feet
- Top Reinforced with (2) 5" "C" Channels
- 32<sup>1/2</sup>" Height



Size: (l x w)	T-304 S/S Flat Table	T-304 S/S Riser Table	LIST PRICE	T-304 S/S 5" Riser Table	LIST PRICE
36" X 30"	WTT-3630	WTTR-3630	\$306	WTTR5-3630	\$341
48" X 30"	WTT-4830	WTTR-4830	\$356	WTTR5-4830	\$393
60" X 30"	WTT-6030	WTTR-6030	\$410	WTTR5-6030	\$456
72" X 30"	WTT-7230	WTTR-7230	\$472	WTTR5-7230	\$530
96" X 30"	WTT-9630	WTTR-9630	\$605	WTTR5-9630	\$680

**Adjustable Table Mount Pot Rack**  
pg. 65



APR-36  
Shown

**Drawer Assembly**  
pg. 74



BKDWR-2015-ASSY-SS  
Shown

**Additional Undershelf**  
pg. 67-68



VTS-3630  
Shown

**BK-ICT - Condiment/ Spice Rack**



See pg. 58 for details



**Check out this Maxed Out Work Table!**



**Overshelf**  
pg. 66



BK-OSS-1248  
Shown

**Casters**  
pg. 76



5SBR-RA-PLY  
Shown

**Item Featured On Facebook!**  
Like our Facebook page and be the first to know about our New Products!



### VFTS -T-430 18 ga. Stainless Steel Filler Tables

- 1 1/2" Riser
- Additional / Replacement Undershelves Available

- Adjustable High Impact Corrosion Resistant Feet



#### W/ Galvanized Legs & Undershelf

Table Part #	Size: (l x w)	LIST PRICE
VFTS-1524	15" X 24"	\$146
VFTS-1530	15" X 30"	\$156
VFTS-1824	18" X 24"	\$150
VFTS-1830	18" X 30"	\$158
VFTS-2430	24" X 30"	\$202

#### W/ Stainless Steel Legs & Undershelf

Table Part #	Size: (l x w)	LIST PRICE
SFTS-1524	15" X 24"	\$281
SFTS-1530	15" X 30"	\$302
SFTS-1824	18" X 24"	\$291
SFTS-1830	18" X 30"	\$317
SFTS-2430	24" X 30"	\$343

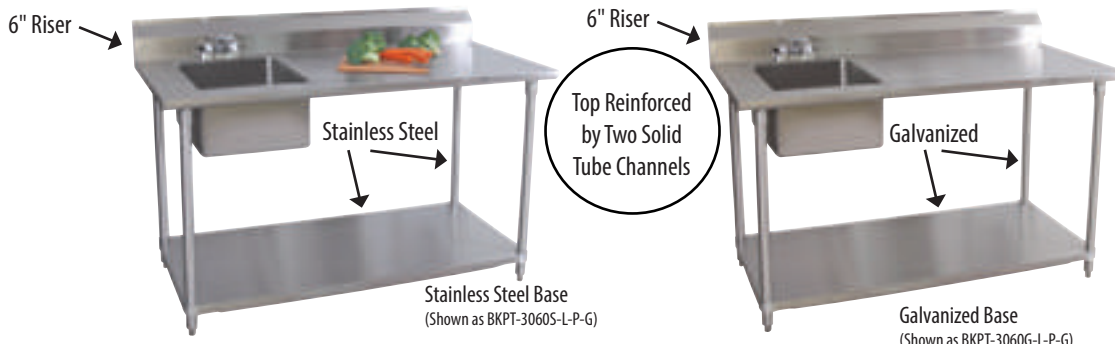

**Add a Prep Basket**

See Pg. 91 for more options.



**BKPT - 18 ga. Stainless Steel Prep-Tables w/ SS Legs & Undershelf**



- Bowl Size: 16" x 20" x 10"(d)
- Includes Basket Drain
- Deck Mount Faucet Installation

Part Number	Sink	Faucet	LIST PRICE	w/ Faucet (BKD-8-G)	LIST PRICE
BKPT-3060S-L	Left	Deck	\$1,208	BKPT-3060S-L-P-G	\$1,275
BKPT-3060S-R	Right	Deck	\$1,208	BKPT-3060S-R-P-G	\$1,275
BKPT-3072S-L	Left	Deck	\$1,290	BKPT-3072S-L-P-G	\$1,356
BKPT-3072S-R	Right	Deck	\$1,290	BKPT-3072S-R-P-G	\$1,356

**BKPT - 18 ga. Stainless Steel Prep-Tables w/ Galv. Legs & Undershelf**



- Bowl Size: 16" x 20" x 10"(d)
- Includes Basket Drain
- Deck Mount Faucet Installation

Part Number	Sink	Faucet	LIST PRICE	w/ Faucet (BKD-8-G)	LIST PRICE
BKPT-3060G-L	Left	Deck	\$980	BKPT-3060G-L-P-G	\$1,046
BKPT-3060G-R	Right	Deck	\$980	BKPT-3060G-R-P-G	\$1,046
BKPT-3072G-L	Left	Deck	\$1,059	BKPT-3072G-L-P-G	\$1,125
BKPT-3072G-R	Right	Deck	\$1,059	BKPT-3072G-R-P-G	\$1,125

**BKDC - Stainless Steel (Enclosed) Cabinet Base Work Table**



- T-304 18 ga. Stainless Steel
- 1 5/8" x 6" Straight S/S Leg
- Legs Adjust 1" in Height



BKDC-2448



BKDC-2448S

New & Improved Rollers

**24" Deep Cabinet Base**

**WITHOUT Sliding Doors**

24" Deep Part Number	Size: (l x w)	LIST PRICE
BKDC-2448	48" x 24"	\$905
BKDC-2460	60" x 24"	\$1,143
BKDC-2472	72" x 24"	\$1,247

**WITH Sliding Doors**

24" Deep Part Number	Size: (l x w)	LIST PRICE
BKDC-2448S	48" x 24"	\$1,352
BKDC-2460S	60" x 24"	\$1,664
BKDC-2472S	72" x 24"	\$1,872

**30" Deep Cabinet Base**

**WITHOUT Sliding Doors**

30" Deep Part Number	Size: (l x w)	LIST PRICE
BKDC-3048	48" x 30"	\$1,144
BKDC-3060	60" x 30"	\$1,248
BKDC-3072	72" x 30"	\$1,404

**WITH Sliding Doors**

30" Deep Part Number	Size: (l x w)	LIST PRICE
BKDC-3048S	48" x 30"	\$1,560
BKDC-3060S	60" x 30"	\$1,820
BKDC-3072S	72" x 30"	\$2,079





Shown as  
BKDWR-2015-ASSY-SS



Shown as  
BKDWR-2015-ASSY-L-SS-SPR-24

### BKDWR - Stainless Steel Drawer Assembly

- ADA Compliant
- 200lb Capacity
- Pan Easily Removes For Cleaning
- 5" Deep Pans

- Drawer Assemblies w/ Spacers are designed to be used with Metal Tables, w/out Spacers are to be used with Wood Tables
- 20 x 20 and 20 x 15 fit both 24" and 30" table depths
- 15 x 20 ONLY fit 18" depth tables and come with 6" Spacers

#### Without Spacers (used with Wood Tables)

Table Part #	NSF	Pan Size: (l x w)	Lock Incl.	Pan Material	LIST PRICE
BKDWR-1820-ASSY-SS	✓	15" x 20"	-	S/S	\$354
BKDWR-1820-ASSY-L-SS	✓	15" x 20"	Yes	S/S	\$374
BKDWR-2020-ASSY-SS	✓	20" x 20"	-	S/S	\$414
BKDWR-2020-ASSY-L-SS	✓	20" x 20"	Yes	S/S	\$462
BKDWR-2015-ASSY-SS	✓	20" x 15"	-	S/S	\$368
BKDWR-2015-ASSY-L-SS	✓	20" x 15"	Yes	S/S	\$414
BKDWR-2020-ASSY-PL		20" x 20"	-	Plastic	\$391
BKDWR-2020-ASSY-L-PL		20" x 20"	Yes	Plastic	\$437
BKDWR-2015-ASSY-PL		20" x 15"	-	Plastic	\$358
BKDWR-2015-ASSY-L-PL		20" x 15"	Yes	Plastic	\$404

#### Spacers Included (used with Metal Tables)

Table Part #	Pan Size: (l x w)	Spacers	Lock Incl.	Pan Material	LIST PRICE
BKDWR-1820-ASSY-PL	15" x 20"	6"	-	Plastic	\$333
BKDWR-1820-ASSY-L-PL	15" x 20"	6"	Yes	Plastic	\$354
BKDWR-2020-ASSY-SS-SPR-24	20" x 20"	24"	-	S/S	\$466
BKDWR-2020-ASSY-L-SS-SPR-24	20" x 20"	24"	Yes	S/S	\$487
BKDWR-2015-ASSY-SS-SPR-24	20" x 15"	24"	-	S/S	\$420
BKDWR-2015-ASSY-L-SS-SPR-24	20" x 15"	24"	Yes	S/S	\$441
BKDWR-2020-ASSY-SS-SPR-30	20" x 20"	30"	-	S/S	\$472
BKDWR-2020-ASSY-L-SS-SPR-30	20" x 20"	30"	Yes	S/S	\$493
BKDWR-2015-ASSY-SS-SPR-30	20" x 15"	30"	-	S/S	\$426
BKDWR-2015-ASSY-L-SS-SPR-30	20" x 15"	30"	Yes	S/S	\$447

## How Many Drawer Assemblies Will Fit My Work Table?

(VTT, SVT, VTTR, SVTR, VTTR5, SVTR5, VTT0B, SVT0B, VTTROB, SVTROB, VTT5ROB, SVT5ROB, WST, WTT, WSTR, WTTR, WSTR5, WTR5)



TABLE WIDTH (Front to Back)	18"	24"	30"	36"	48"	60"	72"	84"	96"
	24"	30"	36"	48"	60"	72"	84"	96"	
18"	N/A	N/A	(1) 18X20	(1) 18X20	(1) 18X20	(2) 18X20	(2) 18X20	(2) 18X20	
24"	N/A	(1) 20X15	(1) 20X20, (1) 20X15	(1) 20X20, (2) 20X15*	(1) 20X20, (2) 20X15	(2) 20X20, (3) 20X15	(2) 20X20, (2) 20X15	(2) 20X20, (4) 20X15	
30"	N/A	(1) 20X15	(1) 20X20, (1) 20X15	(1) 20X20, (2) 20X15*	(1) 20X20, (2) 20X15	(2) 20X20, (3) 20X15	(2) 20X20, (2) 20X15	(2) 20X20, (4) 20X15	

\* with inverted spacers



**VETS - Stainless Steel Equipment Stand w/ Galv. Legs & Undershef**

- T-430 18 ga Stainless Steel Top w/ 1 5/8" Legs
- Top Reinforced w/ 1 1/2" Square Tubing
- 3 Sided 2" Riser w/ Hemmed Edge
- "-6" Engineered to Hold Multiple Equipment Pieces



Table Part #	Size: (l x w x h)	# of Legs Included	LIST PRICE
VETS-1530	16" X 30" X 24"	4	\$196
VETS-1830	19" X 30" X 24"	4	\$218
VETS-2430	25" X 30" X 24"	4	\$264
VETS-3630	37" X 30" X 24"	4	\$345
VETS-4830	49" X 30" X 24"	4	\$404
VETS-6030	61" X 30" X 24"	4	\$472
VETS-7230	73" X 30" X 24"	4	\$530
VETS-7230-6	73" X 30" X 24"	6	\$598



**SVET - Stainless Steel Equipment Stand w/ SS Legs & Undershef**

- T-430 18 ga Stainless Steel Top w/ 1 5/8" Legs
- Top Reinforced w/ 1 1/2" Square Tubing
- 3 Sided 2" Riser w/ Hemmed Edge
- "-6" Engineered to Hold Multiple Equipment Pieces



Table Part #	Size: (l x w x h)	# of Legs Included	LIST PRICE
SVET-1530	16" X 30" X 24"	4	\$380
SVET-1830	19" X 30" X 24"	4	\$416
SVET-2430	25" X 30" X 24"	4	\$473
SVET-3630	37" X 30" X 24"	4	\$520
SVET-4830	49" X 30" X 24"	4	\$624
SVET-6030	61" X 30" X 24"	4	\$728
SVET-7230	73" X 30" X 24"	4	\$806
SVET-7230-6	73" X 30" X 24"	6	\$874



**5SBR-RA-PLY-PS4**

**Work Table Caster Kit POP Box**

LIST PRICE **\$62.00**



• Includes (4) 5SBR-RA-PLY-TLB 5" Casters

**MST- T-304 14 ga. Stainless Steel Machine Stand**

- Top Reinforced with Support Channels
- Adjustable Undershef
- Marine Edge
- 20" Height



**W/ Galvanized Legs & Undershef**

Table Part #	Size: (l x w)	LIST PRICE
MST-2424GS	24" X 24"	\$391
MST-3024GS	30" X 24"	\$404
MST-3030GS	30" X 30"	\$414
MST-3630GS	36" X 30"	\$437

**W/ Stainless Steel Legs & Undershef**

Table Part #	Size: (l x w)	LIST PRICE
MST-2424SS	24" X 24"	\$508
MST-3024SS	30" X 24"	\$553
MST-3030SS	30" X 30"	\$599
MST-3630SS	36" X 30"	\$645

# CASTERS

6 New Caster Models Packaged in P.O.P Boxes!



Email us at [Sales@bk-resources.com](mailto:Sales@bk-resources.com) or contact your sales rep for our Caster Cross Reference Guide

## Caster Kits

See page 77 for our Caster Help Guide

### Universal Plate Caster Kits 300-500lbs

Part #	NSF	Wheel Size	Casters Per Kit	LIST PRICE
3SBR-UP4-PLY-PS4	✓	3"	4	\$65
5HBR-UP4-PLY-PS4	✓	5"	4	\$140
5SBR-UP3-PLY-TLB-PS4		5"	4	\$69
5SBR-UP4-PLY-TLB-PS4		5"	4	\$69

See page 78 for more details

5SBR-UP3-PLY-TLB shown

### 3" Adjustable Height Universal Plate Caster Kit

Part #	NSF	Wheel Size	Casters Per Kit	LIST PRICE
3SBR-UP3AD-PLY-PS4	✓	3"	4	\$155

See page 78 for more details

### 3" Adjustable Height Phenolic Plate Caster Kit

Part #	Wheel Size	Casters Per Kit	LIST PRICE
3SBR-R1PT-PH-TAB-4*	3"	4	\$138

\*Packaged in Standard Brown Box  
See page 78 for more details

### 5" Triangle Plate Caster Kit

Part #	NSF	Wheel Size	Casters Per Kit	LIST PRICE
5HBR-TR5-PLY-PS4	✓	5"	4	\$160

See page 78 for more details

### Equipment Caster Kit

Part #	NSF	Wheel Size	Casters Per Kit	LIST PRICE
5SBR-1PT-PLY-PS4	✓	5"	4	\$60

See page 78 for more details

### Work Table Caster Kits

Part #	NSF	Wheel Size	Casters Per Kit	LIST PRICE
5SBR-RA-LDP-PS4	✓	5"	4	\$59
5SBR-RA-LDP-PS6*	✓	5"	6	\$89
5SBR-RA-PLY-PS4	✓	5"	4	\$62
5SBR-RA-PLY-PS6*	✓	5"	6	\$94

\*Packaged in Standard Brown Box  
See page 80 for more details

5SBR-RA-PLY-TLB shown

### 2.5" Threaded Stem Caster Kit

Part #	NSF	Wheel Size	Casters Per Kit	LIST PRICE
25SBR-4ST-LDP-PS4	✓	2.5"	4	\$90

See page 79 for more details

### 3" Threaded Stem Caster Kit

Part #	NSF	Wheel Size	Casters Per Kit	LIST PRICE
3SBR-15ST-LDP-PS4	✓	3"	4	\$79

See page 79 for more details

### 5" Threaded Stem Oven Caster Kit

Part #	NSF	Wheel Size	Casters Per Kit	LIST PRICE
5SBR-9ST-PH-4	✓	5"	4	\$90

- Includes:
- (2) 5SBR-9ST-PH - 5" Phenolic Wheel w/out Brake
  - (2) 5SBR-9ST-PH-TLB - 5" Phenolic Wheel w/ Brake

See page 79 for more details

# 5SBR-RA-PLY-TLB

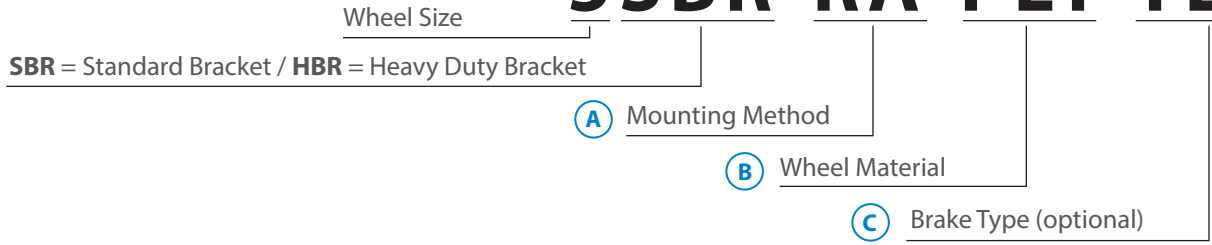

## Available Caster Rigs (A)



**RA** - Expanding Stem

- Zinc Plated
- Dust Covered Raceway Standard
- Double Ball Bearing Raceway For Longer Wear And Added Strength



**PT** - Plate Mount

- Double Ball Bearing Raceway For Long Wear And Added Strength
- Zinc Plated
- 1/2" King Pin



**ST** - Threaded Stem

- 4 Different Stud Sized To Fit Any Application
- Zinc Plated
- Dust Covered Raceway Standard
- Double Ball Bearing Raceway For Longer Wear And Added Strength



**1ST** - Pop In Stem

- Grip Ring For Easy Installation
- Zinc Plated
- Dust Covered Raceway Standard
- Double Ball Bearing Raceway For Longer Wear And Added Strength

## Available Wheel Materials (B)



300 LBS  
WEIGHT CAPACITY

**PLY** - Polyurethane

- Tread Mechanically Bound to Polyolefin Core
- Resistant to Acids & Caustics
- Non-Marking
- Temperature Range -45° to 180°F



350 LBS  
WEIGHT CAPACITY

**PH** - Phenolic

- Resistant to Oil and Grease
- Temperature Range -50° to 250°F
- Easy Rolling, Quieter than Steel Wheels
- Excellent Floor Protection



300 LBS  
WEIGHT CAPACITY

**LDP** - Polyolefin

- Injection Molded
- Impact Resistant
- Non-Marking
- Temperature Range -45° to 180°F
- Highly Resistant to Chemicals and Solvents



300 LBS  
WEIGHT CAPACITY

**HR** - Hard Rubber

- High Impact Molded Rubber
- Temperature Range -40° to 160°F
- Nylon Bearing Sleeve



250 LBS  
WEIGHT CAPACITY

**GR** - Gray Rubber

- Non-Marking
- Temperature Range -45° to 180°F
- Resistant to Oil, Grease, Water and Most Solvents
- Smooth & Quite

## Available Brake Options (C)



**TLB** - Top Lock Brake

- Locks Wheel
- Works With All Wheel Sizes



**TAB** - Toe Activated Brake

- Locks Wheel with Foot Pad
- Works With All Wheel Sizes



**TTB** - Total Lock Brake

- Locks Wheel and Swivel
- Not Available With 3" Wheels

SPECIAL ORDER CASTERS AVAILABLE. CALL FOR PRICING.

**NEW** 4"x 4" Swivel Universal Plate Caster

- 4" x 4" Universal Plate
- 5" Polyurethane Wheel Resistant to Acids & Caustics
- Temperature Range -45° to 180°F
- Top Lock Brake
- 500# Weight Cap. per Caster
- Heavy Duty wheel, rig and plate
- Caster Kit of (4) in POP Box

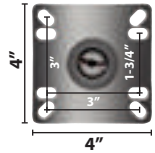

NSF

Part #	Description	LIST PRICE
5HBR-UP4-PLY-PS4	(4) 5" Polyurethane Wheel w/ Top Lock Brake	\$140.00

**NEW** 5-3/8" x 7-1/2" Triangular Swivel Plate Caster

- 5-3/8" x 7-1/2" Triangular Plate
- 5" Polyurethane Wheel Resistant to Acids & Caustics
- Temperature Range -45° to 180°F
- Top Lock Brake
- 500# Weight Cap. per Caster
- Heavy Duty wheel, rig and plate
- Caster Kit of (4) in POP Box
- \*Fits Blodgett® Convection Ovens

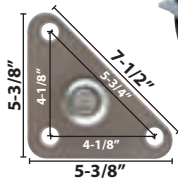

NSF

Part #	Description	LIST PRICE
5HBR-TR5-PLY-PS4	(4) 5" Polyurethane Wheel w/ Top Lock Brake	\$160.00

**NEW** 3-1/2" x 3-1/2" Adjustable Height Universal Plate Caster

- 3-1/2" x 3-1/2" Universal Plate
- 3" Polyurethane Wheel Resistant to Acids & Caustics
- 2" Height Adjustment (from 8 1/2" to 10 1/2")
- Temperature Range -45° to 180°F
- Toe Activated Brake
- 200# Weight Cap. per Caster
- Caster Kit of (4) in POP Box

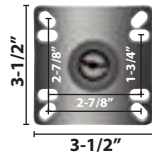

NSF

Part #	Description	LIST PRICE
3SBR-UP3AD-PLY-PS4	(4) 3" Polyurethane Wheel w/ Toe Activated Brake	\$155.00

2-1/2" x 3-5/8" Adjustable Height Plate Caster

- 2-1/2" x 3-5/8" Plate
- 3" Phenolic Wheel Resistant to Oil & Grease
- 1" Height Adjustment (from 6 1/2" to 7 1/2")
- Temperature Range -50° to 250°F
- Toe Activated Brake
- 200# Weight Cap. per Caster
- Caster Kit of (4) in Standard Brown Box

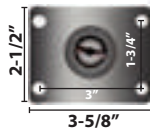

LIST PRICE

Part #	Description	LIST PRICE
3SBR-1PT-PH-TAB-4	(4) 3" Phenolic Wheel w/ Toe Activated Brake	\$138.00

**NEW** 4"x 4" Swivel Universal Plate Caster

- 4" x 4" Universal Plate
- 3" Polyurethane Wheel Resistant to Acids & Caustics
- Temperature Range -45° to 180°F
- Top Lock Brake
- 250# Weight Cap. per Caster
- Caster Kit of (4) in POP Box

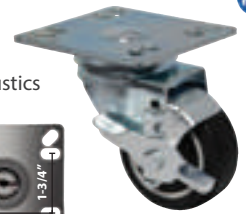
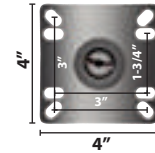

NSF

Part #	Description	LIST PRICE
3SBR-UP4-PLY-PS4	(4) 3" Polyurethane Wheel w/ Top Lock Brake	\$65.00

**Contact Us for our Caster Cross Reference Guide**

3-1/2" x 3-1/2" and 4" x 4" Swivel Universal Plate Caster

- 5" Polyurethane Wheel Resistant to Acids & Caustics
- Temperature Range -45° to 180°F
- Top Lock Brake
- 300# Weight Cap. per Caster
- Caster Kit of (4) in POP Box

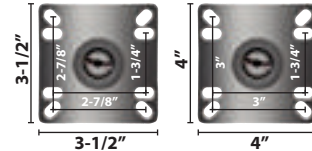

NSF

Part #	Description	LIST PRICE
5SBR-UP3-PLY-TLB-PS4	3-1/2" x 3-1/2" Universal Plate Caster Kit (4) 5" Polyurethane Wheel w/ Top Lock Brake	\$69.00
5SBR-UP3-PLY-TLB	3-1/2" x 3-1/2" Universal Plate Caster 5" Polyurethane Wheel w/ Top Lock Brake	\$17.00
5SBR-UP4-PLY-TLB-PS4	4" x 4" Universal Plate Caster Kit (4) 5" Polyurethane Wheel w/ Top Lock Brake	\$69.00
5SBR-UP4-PLY-TLB	4" x 4" Universal Plate Caster 5" Polyurethane Wheel w/ Top Lock Brake	\$17.00

2-3/8" x 3-5/8" Plate Caster

- 2-3/8" x 3-5/8" Plate
- 5" Polyurethane Wheel Resistant to Acids & Caustics
- Temperature Range -45° to 180°F
- Top Lock Brake
- 300# Weight Cap. per Caster
- Caster Kit of (4) in POP Box

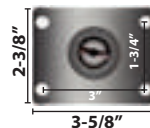

NSF

Part #	Description	LIST PRICE
5SBR-1PT-PLY-PS4	(4) 5" Polyurethane Wheel w/ Top Lock Brake	\$60.00
5SBR-1PT-PLY	5" Polyurethane Wheel	\$12.00
5SBR-1PT-PLY-TLB	5" Polyurethane Wheel w/ Top Lock Brake	\$14.00

\* This product is not manufactured or associated with any other manufacturer, and the products under that registered trade name or mark are not owned, associated or to be confused with BK Resources.

**Threaded Stem**

- Double Ball Bearing Raceway for Long Wear and Added Strength
- Zinc Plated
- Raceway Dust Cover

**APPLICATIONS**

- Wire Shelf Carts
- Bakery Equipment
- Food Service Operations
- Displays
- Maintenance Carts
- Office Equipment

**3/4"-10 x 1" Threaded Stem Oven Caster**

- 3/4"-10 x 1" Threaded Stem
- 5" Phenolic Wheel Resistant to Oil & Grease
- Temperature Range -50° to 250°F
- With or Without Top Lock Brake
- 350# Weight Cap. per Caster
- Caster Kit of (4)
- \* Fits Southbend® & Garland® G-Series



Part #	Description	LIST PRICE
5SBR-9ST-PH-4	Caster Kit Includes: (2) 5" Phenolic Wheel Casters (2) 5" Phenolic Wheel w/ Top Lock Brake Casters	\$90.00

**NEW 1/2"-13 x 1" Threaded Stem Equipment Caster**

- 1/2"-13 x 1" Threaded Stem
- 2.5" Polyolefin Wheel Resistant to Chemicals & Solvents
- Temperature Range -45° to 180°F
- Twist Lock Brake
- 220# Weight Cap. per Caster
- Caster Kit of (4) in POP Box
- \* Fits True® Refrigerators



Part #	Description	LIST PRICE
25SBR-4ST-LDP-PS4	(4) 2.5" Polyolefin Wheel Casters w/ Twist Lock Brake	\$90.00

**NEW 1/2"-13 x 3/4" Threaded Stem Equipment Caster**

- 1/2"-13 x 3/4" Threaded Stem
- 3" Polyolefin Wheel Resistant to Chemicals & Solvents
- Temperature Range -45° to 180°F
- Top Lock Brake
- 220# Weight Cap. per Caster
- Caster Kit of (4) in POP Box



Part #	Description	LIST PRICE
3SBR-15ST-LDP-PS4	(4) 3" Polyolefin Wheel Casters w/ Top Lock Brake	\$79.00

\* This product is not manufactured or associated with any other manufacturer, and the products under that registered trade name or mark are not owned, associated or to be confused with BK Resources.

**Pop In Stem**

- Fits 1" O.D. Tubing
- Double Ball Bearing Raceway for Long Wear and Added Strength
- Zinc Plated
- Raceway Dust Cover

**APPLICATIONS**

- Wire Shelf Carts
- Bakery Equipment
- Food Service Operations
- Displays
- Maintenance Carts
- Office Equipment



**Polyurethane Wheel**

- Resistant to Acids & Caustics
- Temperature Range -45° to 180°F



**Polyolefin Wheel**

- Resistant to Chemicals & Solvents
- Temperature Range -45° to 180°F



Part #	Description	Weight Capacity	LIST PRICE
5SBR-1ST-PLY	5" Polyurethane Wheel Caster	300#	\$18.00
5SBR-1ST-PLY-TLB	5" Polyurethane Wheel Caster w/ Top Lock Brake	300#	\$21.00
5SBR-1ST-LDP	5" Polyolefin Wheel Caster	300#	\$12.00
5SBR-1ST-LDP-TLB	5" Polyolefin Wheel Caster w/ Top Lock Brake	300#	\$14.00

- Double Ball Bearing Raceway for Long Wear and Added Strength
- Zinc Plated
- Raceway Dust Cover
- Thread Covered Not On Solid Wheels. (i.e. Polyolefin, Hard Rubber & Phenolic Wheels)

**APPLICATIONS**

- Work Tables
- Bakery Equipment
- Food Service Operations
- Displays
- Maintenance Carts
- Office Equipment

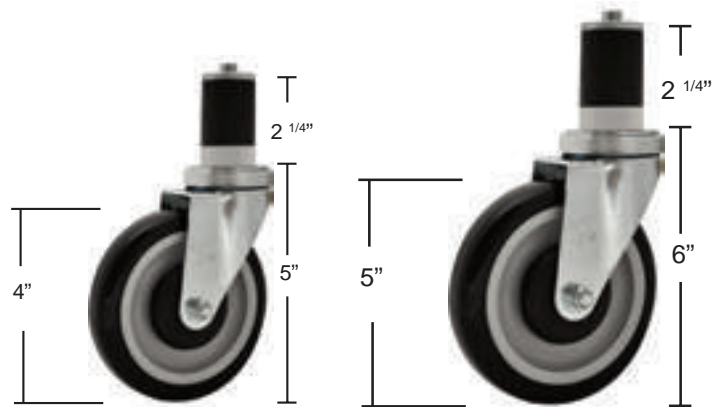

**1-5/8" Stem Work Table Caster**

- Fits Standard 1-5/8" Tubing
- 4" or 5" Polyurethane Wheel Resistant to Acids & Caustics
- Temperature Range -45° to 180°F
- Top Lock Brake
- 300# Weight Cap. per Caster
- Caster Kit of (4 or 6) in POP Box



Part #	Description	LIST PRICE
5SBR-RA-PLY-PS4	(4) 5" Polyurethane Wheel w/ Top Lock Brake	\$62.00
5SBR-RA-PLY-PS6	(6) 5" Polyurethane Wheel w/ Top Lock Brake	\$94.00
5SBR-RA-PLY	5" Polyurethane Wheel	\$14.00
5SBR-RA-PLY-TLB	5" Polyurethane Wheel w/ Top Lock Brake	\$16.00
4SBR-RA-PLY	4" Polyurethane Wheel	\$14.00
4SBR-RA-PLY-TLB	4" Polyurethane Wheel w/ Top Lock Brake	\$16.00

**1-5/8" Stem Work Table Caster**

- Fits Standard 1-5/8" Tubing
- 5" Polyolefin Wheel Resistant to Chemicals & Solvents
- Temperature Range -45° to 180°F
- Top Lock Brake
- 300# Weight Cap. per Caster
- Caster Kit of (4 or 6)



Part #	Description	LIST PRICE
5SBR-RA-LDP-PS4	(4) 5" Polyolefin Wheel w/ Top Lock Brake	\$59.00
5SBR-RA-LDP-PS6	(6) 5" Polyolefin Wheel w/ Top Lock Brake	\$89.00
5SBR-RA-LDP	5" Polyolefin Wheel	\$12.00
5SBR-RA-LDP-TLB	5" Polyolefin Wheel w/ Top Lock Brake	\$14.00



**Hard Rubber Wheel**

- Temperature Range -40° to 160°F



**Gray Rubber Wheel**

- Resistant to Oil, Grease, Water & Most Solvents
- Temperature Range -45° to 180°F



**Phenolic Wheel**

- Resistant to Oil & Grease
- Temperature Range -50° to 250°F

Part #	NSF	Description	Weight Capacity	LIST PRICE
5SBR-RA-HR	✓	5" Hard Rubber Wheel Caster	300#	\$14.00
5SBR-RA-HR-TLB	✓	5" Hard Rubber Wheel Caster w/ Top Lock Brake	300#	\$16.00
5SBR-RA-GR	✓	5" Gray Rubber Wheel Caster	250#	\$14.00
5SBR-RA-GR-TLB	✓	5" Gray Rubber Wheel Caster w/ Top Lock Brake	250#	\$16.00
5SBR-RA-PH	✓	5" Phenolic Wheel Caster	350#	\$42.00
5SBR-RA-PH-TLB	✓	5" Phenolic Wheel Caster w/ Top Lock Brake	350#	\$49.00



**BK-LT1-NW - Round 1" Thick Reversible Natural / Walnut Table Top**

- 1" Thick Particle Board With Multiple Color Options
- Includes Black Vinyl T-Mold Protective Edge
- 1" Thick

Part Number	Recommended Base	Size: (Diameter)	LIST PRICE
BK-LT1-NW-24R	-2222 or -18	24"	\$37
BK-LT1-NW-30R	-2222 or -22	30"	\$51
BK-LT1-NW-36R	-2222 or -22	36"	\$77

**BK-LT1-BM - Round 1" Thick Reversible Black / Mahogany Table Top**

- 1" Thick Particle Board With Multiple Color Options
- Includes Black Vinyl T-Mold Protective Edge
- 1" Thick

Part Number	Recommended Base	Size: (Diameter)	LIST PRICE
BK-LT1-BM-24R	-2222 or -18	24"	\$37
BK-LT1-BM-30R	-2222 or -22	30"	\$50
BK-LT1-BM-36R	-2222 or 22	36"	\$77

**OUR FULL LINE OF INVENTORY IS BACK**

**BK-LT1-NW - 1" Thick Reversible Natural / Walnut Table Top**

- 1" Thick Particle Board With Multiple Color Options
- Includes Black Vinyl T-Mold Protective Edge
- 1" Thick
- 2" Radius Corners

Part Number	Recommended Base	Size: (Diameter)	LIST PRICE
BK-LT1-NW-2424	-2222 or -18	24" x 24"	\$37
BK-LT1-NW-3024	-2222 or -18	30" x 24"	\$44
BK-LT1-NW-3030	-2222 or -22	30" x 30"	\$50
BK-LT1-NW-3636	-2430 or -22	36" x 36"	\$72
BK-LT1-NW-4230	-2430 or -22	42" x 30"	\$73
BK-LT1-NW-4830	-2430 or -22	48" x 30"	\$85

**BK-LT1-BM - 1" Thick Reversible Black / Mahogany Table Top**

- 1" Thick Particle Board With Multiple Color Options
- Includes Black Vinyl T-Mold Protective Edge
- 1" Thick
- 2" Radius Corners

Part Number	Recommended Base	Size: (Diameter)	LIST PRICE
BK-LT1-BM-2424	-2222 or -18	24" x 24"	\$37
BK-LT1-BM-3024	-2222 or -18	30" x 24"	\$44
BK-LT1-BM-3030	-2222 or -22	30" x 30"	\$50
BK-LT1-BM-3636	-2430 or -22	36" x 36"	\$73
BK-LT1-BM-4230	-2430 or -22	42" x 30"	\$73
BK-LT1-BM-4830	-2430 or -33	48" x 30"	\$85





**Bar and Dining Height Table Bases**

- Bar Height 41"
- Dining Height 28"
- Cast Iron Table Bases
- Black Powder Coated Finish
- All Bases Include Floor Glides, Top Spider With Rod and Nut, and Hardware For Mounting

◀ • Units Ship Unassembled • Assembly Required ▶

3 Piece Part #	LIST PRICE	2 Piece Part #	LIST PRICE	Base Type	Recommended Top Size	Base O.A. Measurements	Use Height
BK-DXTB-0522	\$41	BK-DXTB2-0522	\$47	2 Prong	60"	5" x 22"	Dining Height
BK-BXTB-0522	\$49	BK-BXTB2-0522	\$55	2 Prong	60"	5" x 22"	Bar Height
BK-DXTB-2222	\$46	BK-DXTB2-2222	\$52	4 Prong	24"-30"	22" x 22"	Dining Height
BK-BXTB-2222	\$56	BK-BXTB2-2222	\$58	4 Prong	24"-30"	22" x 22"	Bar Height
BK-DXTB-2430	\$53	BK-DXTB2-2430	\$57	4 Prong	30"-60"	24" x 30"	Dining Height
BK-BXTB-2430	\$62	BK-BXTB2-2430	\$67	4 Prong	30"-60"	24" x 30"	Bar Height
BK-DXTB-3030	\$56	BK-DXTB2-3030	\$62	4 Prong	36"-42"	30" x 30"	Dining Height
BK-BXTB-3030	\$60	BK-BXTB2-3030	\$67	4 Prong	36"-42"	30" x 30"	Bar Height
BK-DRTB-18	\$73	BK-DRTB2-18	\$79	Round Base	30"-34"	18"	Dining Height
BK-BRTB-18	\$83	BK-BRTB2-18	\$89	Round Base	30"-34"	18"	Bar Height
BK-DRTB-22	\$96	BK-DRTB2-22	\$102	Round Base	30"-42"	22"	Dining Height
BK-BRTB-22	\$104	BK-BRTB2-22	\$110	Round Base	30"-42"	22"	Bar Height
BK-DRTB-30	\$148	BK-DRTB2-30	\$154	Round Base	48"-60"	30"	Dining Height
BK-BRTB-30	\$156	BK-BRTB2-30	\$162	Round Base	48"-60"	30"	Bar Height



Black  
BK-MLSC-B

Black  
BK-ML30-B



Bronze / Black  
BK-MLSC-BB



**BK-ML - Ladder Back Side Chairs and Bar Stools**

- Full Welded 18 Gauge Steel Frame
- Powder Coated Finish
- Available In 5 Vinyl Colors
- Nylon Non-Marking Feet
- Seat Cushion Dimensions : 16" (w) x 15 1/2" (d) x 1 1/2" (h)

• Seats Ship Separately (Assembly Required)

Part Number	Chair Type / Use	Seat Height	Finish	Overall Dimensions ( w x d x h)	LIST PRICE
BK-MLSC-B	Dining Side Chair	18"	Black	16" x 18 1/2" x 33"	\$87
BK-ML30-B	Bar Stool	30"	Black	16" x 18" x 43"	\$110

**BK-VPS - Vinyl Cushions for BK-ML Chairs and Stools**

LIST PRICE  
**\$24.00**



Black  
BK-VPS-BK



Burgundy  
BK-VPS-BY

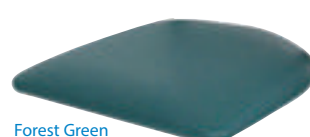

Forest Green  
BK-VPS-GR



**BK-AG Self-Leveling Table Glides**

- For Metal Table Bases
- 1/4-20 x 1/2 Thread

Part Number	LIST PRICE
BK-AG	\$5.50



**BK-AG-4 4 Pack Self-Leveling Table Glides**

- For Metal Table Bases
- 1/4-20 x 1/2 Thread
- P.O.P. Packaging

Part Number	LIST PRICE
BK-AG-4	\$15.50



**BK-SETSCREW**  
Set Screws

- Exclusively for BK Resources Products
- M8 x 8mm

Part #	LIST PRICE	Qty.
BK-SETSCREW-25	\$4	25
BK-SETSCREW-100	\$12	100
BK-SETSCREW-250	\$29	250



**BK-BKFCLEANER**  
Stainless Steel Cleaner

- Net Weight 12 oz.
- Cleans & Polishes S/S
- Sold individually
- Sold in Case

Part #	LIST PRICE	Qty.
BK-BKFCLEANER-12	\$6	ea.
BK-BKFCLEANER-CASE	\$64	12



**BK-SS-CAREKIT**  
Stainless Steel Care & Maintenance Mini Kit

- 2 oz. S/S Polish
- S/S Cleaner
- BK-SS-CAREKIT-SS incl. BK-SETSCREW-25
- Scotch Brite Pad
- S/S Care Kit Instruction

Part #	LIST PRICE
BK-SS-CAREKIT	\$12
BK-SS-CAREKIT-SS	\$15



**BK-SBPAD**  
Scotch Brite  
Cleaning Pads

- Helps Remove Foreign Surfaces from S/S
- Can Be Used To Remove Light Scratches

Part #	LIST PRICE	Qty.
BK-SBPAD	\$62	Box (20 ea.)
BK-SBPAD-CASE	\$185	Case (3 boxes)



**BK-SSCLNR**  
Stainless Steel Polish

- Polishes Stainless Steel To High Gloss Shine
- Helps Preserve Stainless Steel Finish

Part #	LIST PRICE	Size
BK-SSCLNR-10	\$23	10 oz. Can
BK-SSCLNR-10-CASE	\$276	Case (12ea. 10 oz. cans)
BK-SSCLNR-128	\$461	Case (4ea. 1 Gallon)



**BK-SC**  
Silicone Sealant

- 10.1 oz bottle for caulking gun
- Also available in 2 oz. hand held tube

Part #	Color	LIST PRICE	Size
BK-SC-CL	Clear	\$7	10.1 oz.
BK-SC-AL	Aluminum	\$7	10.1 oz.
100711	Clear	\$6	2.8 oz.

**BKGF - S/S Hood Grease Filters**

- T-430 Stainless Steel
- Includes Handles
- Weep Holes
- Non ETL Listed
- 20" h x 20" l
- 6 Per Box

Part Number	h x l	LIST PRICE
BKGF-1216-4SH	16" x 12"	\$26
BKGF-1220-4SH	20" x 12"	\$27
BKGF-2016-4SH	16" x 20"	\$28
BKGF-2020-4SH	20" x 20"	\$29

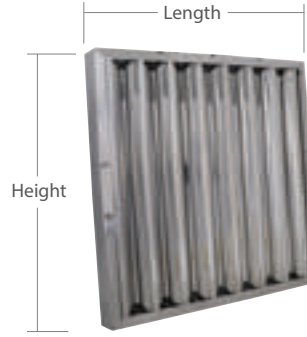

**Catches**

Part Number	Description	LIST PRICE
BK-MAG-1	Magnetic Catch 12 # pull 2-3/4" long	\$4
BK-MAG-SP	Striker Plate	\$1
BK-DBC-1	Large Adjustable Double Ball Catch - 69 mm O.A.L.	\$5



**BK-SRSA - Roller Drawer Slides**

- Supplied w/ 8 Rollers
- 200 lb. Capacity

Part Number	Drawer Slide Length	Roller Mat.	LIST PRICE	Sold In Case Pack Only
BK-SRSA-22	22"	Stainless Bearings	\$60	10
BK-SRSA-24	24"	Stainless Bearings	\$69	10



**BK-FDS / BK-RDS**

**Front & Rear Door Sheaves**

LIST PRICE  
**\$2.00 ea.**

- Nylon Tires



**BK-ADTK - Aluminum Door Tracking**

Part Number	Size	LIST PRICE
BK-ADTK-48	48"	\$19
BK-ADTK-60	60"	\$27
BK-ADTK-72	72"	\$34
BK-ADTK-144	144"	\$44

Drawer Assemblies - Locks - Inserts - Hinges

**BKDWR - S/S Drawer Assemblies**

- 200 lb. Capacity
- ADA Compliant
- Pan Easily Removes for Cleaning

Part Number	NSF	Pan Size	Spacers Included	Pan Material	LIST PRICE
BKDWR-2020-ASSY-SS	✓	20" x 20"	N/A	S/S	\$414
BKDWR-2015-ASSY-SS	✓	20" x 15"	N/A	S/S	\$368
BKDWR-2020-ASSY-PL		20" x 20"	N/A	Plastic	\$391
BKDWR-2015-ASSY-PL		20" x 15"	N/A	Plastic	\$358



Also Shown on Page 74



**Drawer Assemblies w/Locks**

Part Number	NSF	Size	Spacers Included	Pan Material	LIST PRICE
BKDWR-1820-ASSY-L-SS	✓	15" x 20"	6"	S/S	\$374
BKDWR-2020-ASSY-L-SS	✓	20" x 20"	N/A	S/S	\$462
BKDWR-2015-ASSY-L-SS	✓	20" x 15"	N/A	S/S	\$414
BKDWR-1820-ASSY-L-PL		15" x 20"	6"	Plastic	\$354
BKDWR-2020-ASSY-L-PL		20" x 20"	N/A	Plastic	\$437
BKDWR-2015-ASSY-L-PL		20" x 15"	N/A	Plastic	\$404

**BKDWR - Drawer Pans**

- Stainless Pans NSF Component Approved
- Plastic Pans Not NSF Approved

Part Number	Size	Pan Mat.	LIST PRICE	Sold In Case Pack (Optional)
BKDWR-2020	20" x 20" x 5" (d)	Stainless	\$93	10
BKDWR-2015	20" x 15" x 5" (d)	Stainless	\$81	6
BKDWR-2020-PL (Not NSF Listed)	20" x 20" x 5" (d)	Plastic	\$49	6
BKDWR-2015-PL (Not NSF Listed)	20" x 15" x 5" (d)	Plastic	\$40	6



**BK-KI-100**  
Knurled Inserts



LIST PRICE  
**\$1.00**

- Fits 1" Overall Diameter Tubing



**BKCL-125**  
1 1/4" Cylinder Lock  
Keyed Alike

LIST PRICE  
**\$4.00**



**BK-BNCI-1**  
1-1/2" Bullnose  
Corner Insert

LIST PRICE  
**\$2.20**



**BK-RECI-1**  
1-5/8" Rolled  
Corner Edge Insert

LIST PRICE  
**\$2.35**



**BK-RECI-2**  
1 1/2" Cove  
Corner Insert

LIST PRICE  
**\$5.00**



**BK-LOH-1**  
2" S/S Lift Off Hinge  
w/o Holes

LIST PRICE  
**\$2.00**



**BK-LOH-7**  
2" S/S Lift Off Hinge  
w/ Holes

LIST PRICE  
**\$2.00**



**BK-LOH-2**  
3" S/S Lift Off Hinge  
w/o Holes

LIST PRICE  
**\$3.00**



Ⓐ



Ⓑ



Ⓒ

**Handles**

• **Note:** Has 10-24 Threading, 1" or 3/8" Screws Available, **Please Specify Size Screw Needed**

	Part #	Description	LIST PRICE	Sold In Case Pack
A	BKSDRWPL	S/S Drawer Pull w/ Full Grip	\$6.00	100
B	BKSSRPD	S/S Recessed Sliding Door Pull	\$4.20	100
V	BK-TH-12	12" Tubular Handle 1" O.D. Tubing	\$17.00	100

**BK-URTR - Urn Trough w/ Drip Plate**

- T-304 Stainless Steel
- Removable Drip Plate
- 7/8" Deep Tray
- 1" Flush Mount Trim Plate
- 1/4" Rounded Corners on Trim Plate
- 1 1/4" O.D. Drain

Part #	Tray Length:	Overall Length:	LIST PRICE
BK-URTR-18	18"	20"	\$154
BK-URTR-24	24"	26"	\$179
BK-URTR-36	36"	38"	\$231
BK-URTR-48	48"	50"	\$283
BK-URTR-60	60"	62"	\$335
BK-URTR-72	72"	74"	\$385

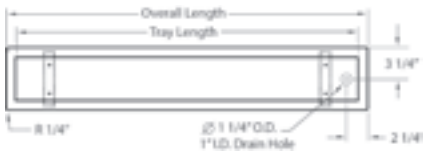
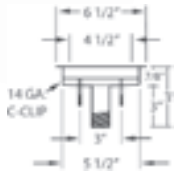

**BK-04000126**  
**S/S Lid Cover Brackets**

LIST PRICE  
**\$14.40**

- Overall Dimensions: 3" x 2 5/8" (t)
- 1/2" Mounting Lip



**BK-SOPB**  
**Single Outlet Pedestal Box**

LIST PRICE  
**\$28.00**

- Brushed Cast Aluminum



**BK-KPSC-1**  
**Kick Plate Spring Clamp**

LIST PRICE  
**\$1.32**

- Fits 1 5/8" and 2" Legs
- Heavy Duty

***New & Improved***  
**ALL Stainless Steel**



**BK-DVEK**  
**Drain Valve Extension Kit**

LIST PRICE  
**\$84.00**

- ALL T-304 Stainless Steel
- Standard with 1/2" Valves

## Legs - Rail Supports



**BKL-20-WP**  
2" x 6" Straight S/S Leg

- With Removable Leg Plate
- Case Pack 24 Only

LIST PRICE  
**\$14.00**



**BKL-1625-WP**  
1 5/8" x 6" Straight S/S Leg

- With Removable Leg Plate
- Case Pack 24 Only

LIST PRICE  
**\$12.00**



**BKL-4-NPE**  
4" Nickel Plated  
Economy Leg

- 750 lbs. Weight Cap. (Static Load)
- 3/8" - 16 Stud

LIST PRICE  
**\$9.00**



**BKL-4-BP**  
4" Black Plastic Leg

- 200 lb. Weight Cap. (Static Load)
- 3/8" - 16 Stud

LIST PRICE  
**\$1.50**



**BKL-4-NPE-H**  
4" S/S Brushed Leg

- 750 lb. Weight Cap. (Static Load)
- 3/8" - 16 Stud

LIST PRICE  
**\$9.00**

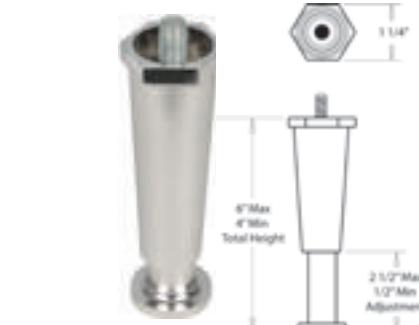

**BKL-4-NPE-N**  
4" S/S Nickel Leg

- 750 lb. Weight Cap. (Static Load)
- 3/8" - 16 Stud

LIST PRICE  
**\$9.00**



**BKBS-1**  
End Tubular Rail Support

- Fits 1-5/8" Legs and 1-1/4 Cross Rail

LIST PRICE  
**\$3.00**



**BKBS-2**  
Corner Tubular Rail Support

- Fits 1-5/8" Legs and 1-1/4 Cross Rails

LIST PRICE  
**\$3.00**



**BKBS-3**  
Center Tubular Rail Support

- Fits 1-5/8" Legs and 1-1/4 Cross Rails

LIST PRICE  
**\$4.00**

### Stainless Steel Tubing

- 20 ft Randoms Also Available - Call for Pricing
- 1 5/8" OD Round
- Includes S/S Adjustable Foot (BK-SSAF) in Precut Lengths
- 16 ga. T-304

NEED A CUSTOM LENGTH?  
WE CAN CUT IT FOR YOU.

Part #	Length	LIST PRICE
BKL-6SS	6"	\$11
BKL-24SS	24"	\$27
BKL-36SS	36"	\$34



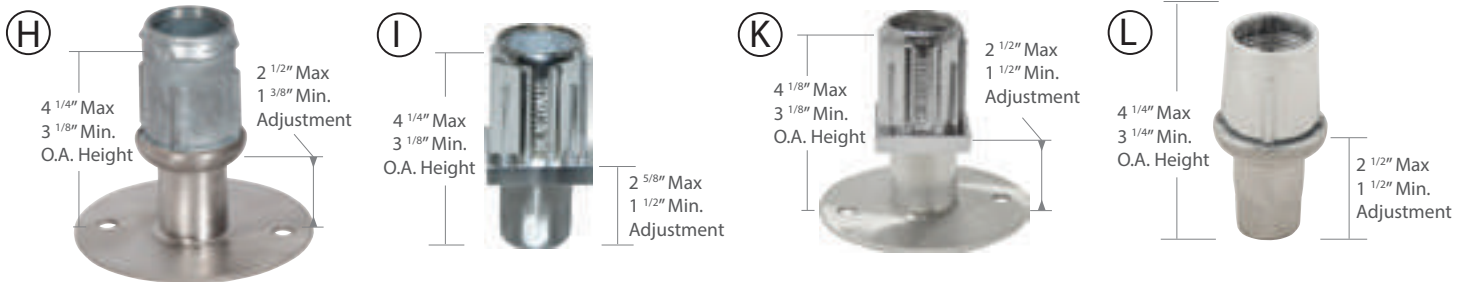
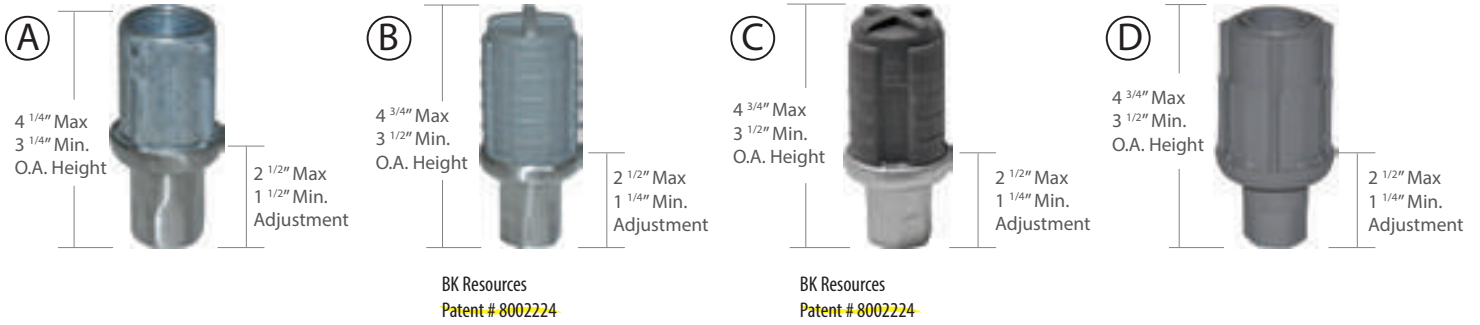

Feet

• Designed for 16 ga. 1-5/8" & 1 1/2" Tubing

	Part Number	NSF	Fits Tubing	Material	Foot Type	Weight Cap. (lbs)	LIST PRICE	Sold In Case Pack Only
A	BK-SSAF	✓	1 5/8" Round	Stainless Steel over White Metal	Bullet	1,000	\$4.00	72
B	BK-SSPAF	✓	1 5/8" Round	Stainless Steel over Plastic	Bullet	200	\$2.00	100
C	BK-WPAF	✓	1 5/8" Round	Aluminum over Plastic	Bullet	250	\$2.00	100
D	BK-PLAF	✓	1 5/8" Round	Plastic	Bullet	200	\$1.00	100
E	BK-WMAF	✓	1 5/8" Round	White Metal	Bullet	1,000	\$4.00	72
F	BK-SPRFAF-WH	✓	1 5/8" Round	Stainless Steel over Plastic	Flange w/ Holes	350	\$7.00	25
G	BK-SSRFAF	✓	1 5/8" Round	Stainless Steel over White Metal	Flange w/o Holes	1,000	\$10.00	25
H	BK-SSRFAF-WH	✓	1 5/8" Round	Stainless Steel over White Metal	Flange w/ Holes	1,000	\$10.00	25
I	BK-SSQAF	✓	1 1/2" Square	Stainless Steel over White Metal	Bullet	1,000	\$6.00	25
K	BK-SSQAF-WH	✓	1 1/2" Square	Stainless Steel over White Metal	Flange w/ Holes	1,000	\$11.00	25
L	BK-15SSAF		1 1/2" Square	Stainless Steel over White Metal	Bullet	1,000	\$4.00	72

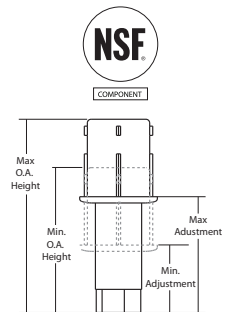





**Leg Sockets**

	Fits	Part Number	NSF	Description	LIST PRICE	Sold In Case Pack Only
A	1-5/8"	BK-SSLSF	✓	S/S w/ Flare w/ 1 Screw	\$4.00	100
B	1-5/8"	BK-SSLS	✓	Straight S/S w/ 2 Screws	\$4.00	100
C	1-5/8"	BK-SSLSF-2	✓	Mini S/S Gusset w/ Flare	\$2.50	100
D	1-5/8"	BK-SSLS-WP	✓	S/S w/ Plate w/ 2 Screws	\$7.00	100
E	1-5/8"	BK-WMLS	✓	Straight Galv. w/ 2 Screws	\$2.00	100
F	1-5/8"	BK-WMLS-1	✓	Straight Galv. w/ 1 Screw	\$2.00	100
G	1-5/8"	BK-WMLS-WP	✓	Galv. w/ Plate w/ 2 Screws	\$6.00	100
H	1-5/8"	BK-DBLS-1	✓	Mini S/S Double-Bevelled Gusset	\$2.50	100
I	1-5/8"	BK-DBLS-2	✓	S/S Double-Bevelled Gusset 3.25"	\$4.50	100
J	1-5/8"	BK-SSLS-1	✓	Straight S/S w/ 1 Screw	\$4.50	100



**BKFB - T-304 Welded Bowls**

- Polished Interior / Unpolished Exterior
- Bowls Conform To NSF-C2 w/ 3/4" Coved Corners
- Bottom Crowned To 3 1/2" Embossed Drain Opening
- Integral Slope Drain Design

We Can Create  
**CUSTOM MADE**  
Fabricated Bowls  
Just for You!

Contact Us for Details!

14 ga. Bowls		1-5	6-10	11-19	20+	16 ga. Bowl		1-5	6-10	11-19	20+
Part Number	Size	Bowls*	Bowls*	Bowls*	Bowls*	Part Number	Size	Bowls*	Bowls*	Bowls*	Bowls*
BKFB-1410-8-14	14 x 10 x 8 (d)	\$208.00	\$198.00	\$187.00	\$177.00	BKFB-1115-11-16	11 x 15 x 11(d)	\$202.00	\$192.00	\$182.00	\$172.00
BKFB-2020-12-14	20 x 20 x 12(d)	\$449.00	\$427.00	\$404.00	\$382.00	BKFB-1616-10-16	16 x 16 x 10(d)	\$243.00	\$231.00	\$219.00	\$207.00
BKFB-2028-12-14	20 x 28 x 12(d)	\$518.00	\$492.00	\$466.00	\$440.00	BKFB-1618-12-16	16 x 18 x 12(d)	\$277.00	\$263.00	\$249.00	\$236.00
BKFB-2028-14-14	20 x 28 x 14(d)	\$580.00	\$551.00	\$522.00	\$493.00	BKFB-1818-12-16	18 x 18 x 12(d)	\$314.00	\$298.00	\$283.00	\$267.00
BKFB-2424-14-14	24 x 24 x 14(d)	\$564.00	\$536.00	\$508.00	\$479.00	BKFB-1620-12-16	16 x 20 x 12(d)	\$291.00	\$277.00	\$262.00	\$247.00
BKFB-1824-14-14	18 x 24 x 14(d)	\$489.00	\$465.00	\$440.00	\$416.00	BKFB-2020-8-16	20 x 20 x 8(d)	\$258.00	\$245.00	\$232.00	\$219.00
BKFB-1431-14-14	14 x 31 x 14(d)	\$564.00	\$536.00	\$508.00	\$479.00	BKFB-2020-12-16	20 x 20 x 16(d)	\$320.00	\$304.00	\$288.00	\$272.00
BKFB-3024-14-14	30 x 24 x 14(d)	\$643.00	\$611.00	\$579.00	\$547.00	BKFB-2028-12-16	20 x 28 x 12(d)	\$391.00	\$372.00	\$352.00	\$332.00
BKFB-1830-12-14	18 x 30 x 12(d)	\$530.00	\$504.00	\$477.00	\$451.00	BKFB-2424-12-16	24 x 24 x 12(d)	\$381.00	\$362.00	\$343.00	\$324.00
BKFB-2030-12-14	20 x 30 x 12(d)	\$593.00	\$563.00	\$534.00	\$504.00	BKFB-2430-12-16	24 x 30 x 12(d)	\$485.00	\$461.00	\$437.00	\$412.00
						BKFB-1431-12-16	14 x 31 x 12(d)	\$337.00	\$320.00	\$303.00	\$287.00
						BKFB-1824-12-16	18 x 24 x 12(d)	\$381.00	\$362.00	\$343.00	\$324.00
						BKFB-3024-12-16	30 x 24 x 12(d)	\$456.00	\$433.00	\$410.00	\$388.00
						BKFB-2424-14-16	24 x 24 x 14(d)	\$441.00	\$419.00	\$397.00	\$375.00
						BKFB-1818-14-16	18 x 18 x 14(d)	\$322.00	\$306.00	\$290.00	\$274.00
						BKFB-1618-14-16	16 x 18 x 14(d)	\$293.00	\$278.00	\$264.00	\$249.00

\*Volume pricing = total bowls on order



**BK-PB  
Prep Basket**

- Designed to fit Fabricated Bowl, Drop-In Sink, Underbar Sinks and Compartment Sinks
- 16 ga. T-304 Stainless Steel
- 2" Deep

Part Number	Fits Bowl Size (w x l)	LIST PRICE
BK-PB1014	10 x 14	\$70
BK-PB1620	16 x 20	\$112



**SB-16-2020-5  
16 ga. T-304 S/S  
Pre-Rinse Bowls**

- 20 x 20 x 5 (d)
- Polished Interior / Exterior
- Bowls Conform To NSFC2 w/ 3/4" Coved Corners
- Bottom Crowned To 3 1/2" Embossed Drain Opening
- Integral Slope Drain Design

LIST PRICE  
**\$210.00**



**BK-SDTS  
Tray Slide**

- T-304 Stainless Steel
- #4 Polish
- 3/16" Bar Stock

Part Number	Fits Bowl Size (wx l)	LIST PRICE
BK-SDTS	20"x20"	\$121
BK-SDTS-1824	18"x24"	\$135

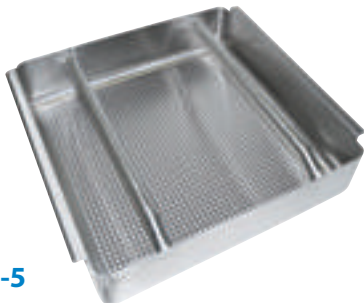

**BK-PRB-5  
T-304 16 ga.  
S/S Pre-Rinse Basket**

- Fits 20 x 20 Bowl
- Redesigned for easier use

LIST PRICE  
**\$218.00**

Brackets - Nuts - Tube Inserts - Weld Studs - Pot Hooks - Flat Bar - Paint



**BK-DSB-SS**  
**Die Cast Chrome Shelf Bracket**  
 LIST PRICE **\$22.00**

- With Stainless Steel Slide
- Collapsible



**BK-3RTSB-F**  
**S/S Tray Slide Rail Bracket**  
 LIST PRICE **\$17.00**

- For Support of 1" O.D. Tubing
- 12 1/2" Length



**BK-3RTSB-D**  
**S/S Drop Tray Slide Rail Bracket**  
 LIST PRICE **\$34.00**

- For Support of 1" O.D. Tubing
- 12 1/2" Length
- Adjustable Leveling Set Screw



**BK-NPDN-1024**  
**#10-24 Nickel Plated Dome Nut**  
 LIST PRICE **\$208.00**

- Sold Per Thousand Only



**BK-NPDN-1024S**  
**#10-24 Dome Nut w/ Seal**  
 LIST PRICE **\$404.00**

- Sold Per Thousand Only



**BK-ZPLN-1024**  
**#10-24 Open Pal Nut**  
 LIST PRICE **\$115.00**

- Sold Per Thousand Only



**BK-NPTI-15R**  
**Nickel Plated Tube Insert**  
 LIST PRICE **\$2.00**

- Fits 1 1/2" O.D. Tubing

**BK-CWS / BK-SWS - Copper & Stainless Weld Studs**

- Sold Per Thousand Only
- M Tip
- 5 Business Day Lead Time

Copper Welds	Size	LIST PRICE	Stainless Welds	Size	LIST PRICE
BK-CWS-1024x1/2	#10-24 x 1/2"	\$92.00	BK-SWS-1024x1/2	#10-24 x 1/2"	\$166.00
BK-CWS-1024x3/8	#10-24 x 3/8"	\$92.00	BK-SWS-1024x3/8	#10-24 x 3/8"	\$185.00
BK-CWS-1024x3/4	#10-24 x 3/4"	\$277.00	BK-SWS-1024x3/4	#10-24 x 3/4"	\$368.00



**Pot Hooks**

- T-304 Stainless Steel
- Single & Double Pot Hooks Available

Part Number	Hook Type	LIST PRICE
<b>Stainless Pot Hooks</b>		
BKSSDPH	Double	\$2.00
BKSSPH	Single	\$2.00



**BK-SSFLAT**  
**S/S Flat Bar**  
 LIST PRICE **\$17.00**

- Sold Per Foot
- 2" T-304 Stainless Steel
- 3/16" x 2"
- 12' Section in Bundles of 10pc.
- Sold Only in Bundles of 10pc.



**BK-AP**  
**Aerosol Paint 10oz. Can**

- Must Purchase in Case Packs
- Sold in 12ea. Case Pack

Part #	Color	LIST PRICE
BK-AP-AL	Aluminum	\$6.00
BK-AP-BL	Flat Black	\$6.00

Part #	Page #	Part #	Page #	Part #	Page #	Part #	Page #
005031	27	5SBR-RA-HR	80	BK-ABPR-1S	63	BK-CM96PR	65
005032	27	5SBR-RA-HR-TLB	80	BK-ABPR-2	63	BK-CWS-1024x1/2	92
06000049	8	5SBR-RA-LDP	80	BK-ABPR-2S	63	BK-CWS-1024x3/4	92
06000063	8	5SBR-RA-LDP-PS4	80	BK-ABPR-CVR1	63	BK-CWS-1024x3/8	92
06000084	8	5SBR-RA-LDP-PS6	80	BK-ABPRZ-1	63	BK-DAB	28
06000086	8	5SBR-RA-LDP-TLB	80	BK-ABPRZ-1S	63	BK-DAC	28
06000166	8	5SBR-RA-PH	80	BK-ADR-3620-12	66	BK-DAS	28
06000183	8	5SBR-RA-PH-TLB	80	BK-ADR-3624-12	66	BK-DBC-1	85
06001001	8	5SBR-RA-PLY	80	BK-ADR-4820-12	66	BK-DBLS-1	90
06001002	8	5SBR-RA-PLY-PS4	80	BK-ADR-4824-12	66	BK-DBLS-2	90
06001004	8	5SBR-RA-PLY-PS6	80	BK-ADR-6020-12	66	BK-DC-35	28
06001005	8	5SBR-RA-PLY-TLB	80	BK-ADR-6024-12	66	BK-DI1014-SS	35
06009010	8	5SBR-UP3-PLY-TLB	78	BK-ADTK-144	85	BK-DI1014-SS	39
06522065	8	5SBR-UP3-PLY-TLB-PS4	78	BK-ADTK-48	85	BK-DIBHL-2118	40
06522070	8	5SBR-UP4-PLY-TLB	78	BK-ADTK-60	85	BK-DIBHL-2118-P-G	40
06522090	8	5SBR-UP4-PLY-TLB-PS4	78	BK-ADTK-72	85	BK-DIBL-1218	40
06522092	8	AOBS-12	57	BK-AG	83	BK-DIBL-2218	40
06530008	8	AOBS-18	57	BK-AG-4	83	BK-DIBL-2818	40
06530013	8	Apr-36	65	BK-AP-AL	92	BK-DIBL-3418	40
06530018	8	Apr-48	65	BK-AP-BL	92	BK-DIS-0909-5	39
07040076	8	APR-60	65	BK-BKFCLEANER-12	84	BK-DIS-0909-5-P-G	39
07100005	8	APR-72	65	BK-BKFCLEANER-CASE	84	BK-DIS-1014-10	39
100711	84	APR-36BAR	65	BK-BNCL-1	86	BK-DIS-1014-10-P-G	39
25SBR-4ST-LDP-PS4	79	APR-48BAR	65	BK-BPD-1	63	BK-DIS-1014-10-SS	39
3SBR-15ST-LDP-PS4-PS4	79	APR-60BAR	65	BK-BRTB-18	82	BK-DIS-1014-10-SS-P-G	39
3SBR-R1PT-PH-TAB-4	78	APR-72BAR	65	BK-BRTB-22	82	BK-DIS-1014-2	39
3SBR-UP3AD-PLY-PS4	78	BB-2-59	49	BK-BRTB-30	82	BK-DIS-1014-2-P-G	39
3SBR-UP4-PLY-PS4	78	BB-2-69	49	BK-BRTB2-18	82	BK-DIS-1014-3	40
4SBR-RA-PLY	80	BB-2G-59	49	BK-BRTB2-22	82	BK-DIS-1014-3-12T	40
4SBR-RA-PLY-TLB	80	BB-2G-69	49	BK-BRTB2-30	82	BK-DIS-1014-3-18T	40
5HBR-UP4-PLY-PS4	78	BB-3-95	49	BK-BXTB-0522	82	BK-DIS-1014-3-P-G	40
5HBR-TR5-PLY-PS4	78	BB-3G-95	49	BK-BXTB-2222	82	BK-DIS-1014-5-SS	39
5SBR-1PT-PLY	78	BC-2-50	50	BK-BXTB-2430	82	BK-DIS-1014-5-SS-P-G	39
5SBR-1PT-PLY-PS4	78	BC-2-65	50	BK-BXTB-3030	82	BK-DIS-1014-5D	39
5SBR-1PT-PLY-TLB	78	BC-3-95	50	BK-BXTB2-0522	82	BK-DIS-1014-5D-P-G	39
5SBR-1ST-LDP	79	BK-04000126	87	BK-BXTB2-2222	82	BK-DIS-1416-2	39
5SBR-1ST-LDP-TLB	79	BK-15SSAF	89	BK-BXTB2-2430	82	BK-DIS-1416-2-P-G	39
5SBR-1ST-PLY	79	BK-3.5RP-G	14	BK-BXTB2-3030	82	BK-DIS-1515	39
5SBR-1ST-PLY-TLB	79	BK-3RTSB-D	92	BK-CM36PR	65	BK-DIS-1515-P-G	39
5SBR-9ST-PH-4	79	BK-3RTSB-F	92	BK-CM48PR	65	BK-DIS-1620-3	40
5SBR-RA-GR	80	BK-6LW-0	27	BK-CM60PR	65	BK-DIS-1620-3-P-G	40
5SBR-RA-GR-TLB	80	BK-ABPR-1	63	BK-CM72PR	65	BK-DIS-1620-3ME	40

Part #	Page #	Part #	Page #	Part #	Page #	Part #	Page #
BK-DIS-1620-3ME-P-G	40	BK-GT-40	51	BK-LWR-20	27	BK-PR-18RP-G	14
BK-DIS-2016-12	39	BK-GT-50	51	BK-LWR-3	27	BK-PR-24RP-G	14
BK-DIS-2016-12-P-G	39	BK-GT-70	51	BK-MAG-1	85	BK-PR-SHR	14
BK-DIS-2016-2	39	BK-GT-8	51	BK-MAG-SP	85	BK-PR-SPR	14
BK-DIS-2016-2-P-G	39	BK-GT-EXT100	50	BK-MIB-2411	57	BK-PR-SPRING	14
BK-DIS-2016-8	39	BK-GT-EXT14	50	BK-MIB-2422	57	BK-PR-WB	14
BK-DIS-2016-8-P-G	39	BK-GT-EXT20	50	BK-ML30-B	83	BK-PRB-5	44
BK-DIS-2820	39	BK-GT-EXT30	50	BK-MLSC-B	83	BK-PRB-5	91
BK-DIS-2820-P-G	39	BK-GT-EXT40	50	BK-NGPR-24	61	BK-PRV-1-G	14
BK-DIWSBL-2118G	40	BK-GT-EXT50	50	BK-NGPR-36	61	BK-PRV-G	14
BK-DIWSBL-2118G-P-G	40	BK-GT-EXT70	50	BK-NGPR-48	61	BK-PTTP	28
BK-DIWSBL-2118X	40	BK-GT-EXT8	50	BK-NGPR-60	61	BK-RECI-1	86
BK-DIWSBL-2118X-P-G	40	BK-GT-SEAL	50	BK-NGPR-72	61	BK-RECI-2	86
BK-DMMK	18	BK-IBBH	57	BK-NGPR-96	61	BK-SBPAD	84
BK-DMMK	25	BK-IBBH18	57	BK-NPDN-1024	92	BK-SBPAD-CASE	84
BK-DMMK-90	18	BK-ICT	58	BK-NPDN-1024S	92	BK-SC-AL	84
BK-DMMK-90	25	BK-KI-100	86	BK-NPTI-15R	92	BK-SC-CL	84
BK-DRTB-18	82	BK-KPSC-1	87	BK-OSD-1236	66	BK-SD	28
BK-DRTB-22	82	BK-LOH-1	86	BK-OSD-1248	66	BK-SD	36
BK-DRTB-30	82	BK-LOH-2	86	BK-OSD-1260	66	BK-SDTS	44
BK-DRTB2-18	82	BK-LOH-7	86	BK-OSD-1272	66	BK-SDTS	91
BK-DRTB2-22	82	BK-LT1-BM-2424	81	BK-OSD-1296	66	BK-SDTS-1824	44
BK-DRTB2-30	82	BK-LT1-BM-24R	81	BK-OSD-1836	66	BK-SDTS-1824	91
BK-DSB-SS	92	BK-LT1-BM-3024	81	BK-OSD-1848	66	BK-SETSCREW-100	84
BK-DVEK	87	BK-LT1-BM-3030	81	BK-OSD-1860	66	BK-SETSCREW-25	84
BK-DWBA	19	BK-LT1-BM-30R	81	BK-OSD-1872	66	BK-SETSCREW-250	84
BK-DXTB-0522	82	BK-LT1-BM-3636	81	BK-OSD-1896	66	BK-SFH-48	34
BK-DXTB-2222	82	BK-LT1-BM-36R	81	BK-OSS-1236	66	BK-SGF-G	40
BK-DXTB-2430	82	BK-LT1-BM-4230	81	BK-OSS-1248	66	BK-SGF-G	19
BK-DXTB-3030	82	BK-LT1-BM-4830	81	BK-OSS-1260	66	BK-SGI-100	46
BK-DXTB2-0522	82	BK-LT1-NW-2424	81	BK-OSS-1272	66	BK-SGI-14	46
BK-DXTB2-2222	82	BK-LT1-NW-24R	81	BK-OSS-1296	66	BK-SGI-20	46
BK-DXTB2-2430	82	BK-LT1-NW-3024	81	BK-OSS-1836	66	BK-SGI-30	46
BK-DXTB2-3030	82	BK-LT1-NW-3030	81	BK-OSS-1848	66	BK-SGI-40	46
BK-FDS/BK-RDS	85	BK-LT1-NW-30R	81	BK-OSS-1860	66	BK-SGI-50	46
BK-FSS	35	BK-LT1-NW-3636	81	BK-OSS-1872	66	BK-SGI-70	46
BK-GRD-1	62	BK-LT1-NW-36R	81	BK-OSS-1896	66	BK-SGI-8	46
BK-GRD-2	62	BK-LT1-NW-4230	81	BK-OT-15075	28	BK-SLW-1	27
BK-GT-100	51	BK-LT1-NW-4830	81	BK-OT-15105	28	BK-SLW-10	27
BK-GT-14	51	BK-LWR-1	27	BK-PB1014	91	BK-SLW-2	27
BK-GT-20	51	BK-LWR-10	27	BK-PB1620	91	BK-SLW-20	27
BK-GT-30	51	BK-LWR-2	27	BK-PLAF	89	BK-SLW-3	27

Part #	Page #	Part #	Page #	Part #	Page #	Part #	Page #
BK-SOPB	87	BK-TSH-42	58	BK8BS-1-18-14	33	BKCDT-60-L-SS	43
BK-SPRFAF-WH	89	BK-TSH-63	44	BK8BS-1-1821-14	33	BKCDT-60-R	43
BK-SRSA-22	85	BK-TSH-63	58	BK8BS-1-24-14	33	BKCDT-60-R-SS	43
BK-SRSA-24	85	BK-URTR-18	87	BK8BS-2-18-12	33	BKCDT-72-L	43
BK-SS-CAREKIT	84	BK-URTR-24	87	BK8BS-2-1821-12	33	BKCDT-72-L-SS	43
BK-SS-CAREKIT-SS	84	BK-URTR-36	87	BK8BS-2-24-12	33	BKCDT-72-R	43
BK-SSAF	89	BK-URTR-48	87	BK8BS-3-1221-12	33	BKCDT-72-R-SS	43
BK-SSCLNR-10	84	BK-URTR-60	87	BK8BS-3-18-12	33	BKCL-125	86
BK-SSCLNR-10-CASE	84	BK-URTR-72	87	BK8BS-3-1821-12	33	BKCS-3-18-14-18T	31
BK-SSCLNR-128	84	BK-UTH-5	34	BK8BS-3-24-12	33	BKCS-3-18-14-24T	31
BK-SSFLAT	92	BK-VPS-BK	83	BK8BS-DD18	33	BKCS-3-24-14-24T	31
BK-SSH-21	44	BK-VPS-BL	83	BK8BS-DD1821	33	BKD-10-G	20
BK-SSH-21	58	BK-VPS-BY	83	BK8BS-DD24	33	BKD-12-G	20
BK-SSH-42	44	BK-VPS-GR	83	BK8D-W-6-G	20	BKD-14-G	20
BK-SSH-42	58	BK-WMAF	89	BK8D-W-8-G	20	BKD-16-G	20
BK-SSH-63	44	BK-WMLS	90	BK8D-W-10-G	20	BKD-18-G	20
BK-SSH-63	58	BK-WMLS-1	90	BK8D-W-12-G	20	BKD-3G-G	20
BK-SSLS	90	BK-WMLS-WP	90	BK8D-W-14-G	20	BKD-5G-G	20
BK-SSLS-1	90	BK-WPAF	89	BK8D-W-16-G	20	BKD-6-G	20
BK-SSLS-WP	90	BK-WPR1-48	65	BK8D-W-18-G	20	BKD-8-G	20
BK-SSLSF	90	BK-WPR1-60	65	BK8D-W-3G-G	20	BKD-8G-G	20
BK-SSLSF-2	90	BK-WPR1-72	65	BK8D-W-5G-G	20	BKDC-1536	62
BK-SSPAF	89	BK-WPR2-48	65	BK8D-W-8G-G	20	BKDC-1548	62
BK-SSQAF	89	BK-WPR2-60	65	BKBS-1	88	BKDC-1560	62
BK-SSQAF-WH	89	BK-WPR2-72	65	BKBS-2	88	BKDC-1572	62
BK-SSRFAF	89	BK-WS	19	BKBS-3	88	BKDC-1836	62
BK-SSRFAF-WH	89	BK-WS	40	BKC-1524S-3S	64	BKDC-1848	62
BK-ST-ADR-2420-12	66	BK-WS-1SGF-G	19	BKC-1827S-3S	64	BKDC-1860	62
BK-ST-ADR-3620-12	66	BK-WS-1SGF-G	40	BKC-2133S-2H	64	BKDC-1872	62
BK-ST-ADR-3624-12	66	BK-ZPLN-1024	92	BKCDT-26-L	43	BKDC-2124-2H	58
BK-ST-ADR-4820-12	66	BK1-SNGWS-12-2	61	BKCDT-26-L-SS	43	BKDC-2448	73
BK-ST-ADR-4824-12	66	BK1-SNGWS-12-3	61	BKCDT-26-R	43	BKDC-2448S	73
BK-ST-ADR-6020-12	66	BK1-SNGWS-12-4	61	BKCDT-26-R-SS	43	BKDC-2460	73
BK-ST-ADR-6024-12	66	BK1-SNGWS-12-5	61	BKCDT-36-L	43	BKDC-2460S	73
BK-SWS-1024x1/2	92	BK1-SNGWS-12-6	61	BKCDT-36-L-SS	43	BKDC-2472	73
BK-SWS-1024x3/4	92	BK1-SNGWS-12-8	61	BKCDT-36-R	43	BKDC-2472S	73
BK-SWS-1024x3/8	92	BK2-SNGWS-16-2	61	BKCDT-36-R-SS	43	BKDC-3048	73
BK-TBDA	28	BK2-SNGWS-16-3	61	BKCDT-48-L	43	BKDC-3048S	73
BK-TH-12	87	BK2-SNGWS-16-4	61	BKCDT-48-L-SS	43	BKDC-3060	73
BK-TSH-22	44	BK2-SNGWS-16-5	61	BKCDT-48-R	43	BKDC-3060S	73
BK-TSH-22	58	BK2-SNGWS-16-6	61	BKCDT-48-R-SS	43	BKDC-3072	73
BK-TSH-42	44	BK2-SNGWS-16-8	61	BKCDT-60-L	43	BKDC-3072S	73

Part #	Page #	Part #	Page #	Part #	Page #	Part #	Page #
BKDR-15BR	28	BKDWR-2020-ASSY-L-PL	86	BKF-4SM-8-G	22	BKF-8SMUS-G	25
BKDR-15CP	28	BKDWR-2020-ASSY-L-SS	74	BKF-4SM-8G-G	22	BKF-8W-10-G	20
BKDR-2	28	BKDWR-2020-ASSY-L-SS	86	BKF-4SM2-10-G	22	BKF-8W-12-G	20
BKDR-305BR	28	BKDWR-2020-ASSY-L-SS-SPR-24	74	BKF-4SM2-12-G	22	BKF-8W-14-G	20
BKDR-305CP	28	BKDWR-2020-ASSY-L-SS-SPR-30	74	BKF-4SM2-14-G	22	BKF-8W-16-G	20
BKDR-325BR	28	BKDWR-2020-ASSY-PL	74	BKF-4SM2-16-G	22	BKF-8W-18-G	20
BKDR-325CP	28	BKDWR-2020-ASSY-PL	86	BKF-4SM2-18-G	22	BKF-8W-3G-G	20
BKDR-335BR	28	BKDWR-2020-ASSY-SS	74	BKF-4SM2-3G-G	22	BKF-8W-5G-G	20
BKDR-335CP	28	BKDWR-2020-ASSY-SS	86	BKF-4SM2-5G-G	22	BKF-8W-6-G	20
BKDR-33BR	28	BKDWR-2020-ASSY-SS-SPR-24	74	BKF-4SM2-6-G	22	BKF-8W-8-G	20
BKDR-33CP	28	BKDWR-2020-ASSY-SS-SPR-30	74	BKF-4SM2-8-G	22	BKF-8W-8G-G	20
BKDR-4	28	BKDWR-2020-PL	86	BKF-4SM2-8G-G	22	BKF-8W-CV-G	17
BKDR-4-304	28	BKF-10-G	21	BKF-5G-G	21	BKF-8W-CVC-G	17
BKDR-HD4	28	BKF-12-G	21	BKF-6-G	21	BKF-8W-ESC	18
BKDTK-26-L-G	44	BKF-14-G	21	BKF-8-G	21	BKF-8W-HV-G	17
BKDTK-26-R-G	44	BKF-16-G	21	BKF-8DM-10-G	21	BKF-8W-HVC-G	17
BKDTK-48-L-G	44	BKF-18-G	21	BKF-8DM-12-G	21	BKF-AF-10-G	18
BKDTK-48-R-G	44	BKF-1SMFD-G	6	BKF-8DM-14-G	21	BKF-AF-12-G	18
BKDTK-72-L-G	44	BKF-3G-G	21	BKF-8DM-16-G	21	BKF-AF-14-G	18
BKDTK-72-R-G	44	BKF-4DM-10-G	22	BKF-8DM-18-G	21	BKF-AF-16-G	18
BKDWR-1820-ASSY-L-PL	74	BKF-4DM-12-G	22	BKF-8DM-3G-G	21	BKF-AF-18-G	18
BKDWR-1820-ASSY-L-PL	86	BKF-4DM-14-G	22	BKF-8DM-5G-G	21	BKF-AF-6-G	18
BKDWR-1820-ASSY-L-SS	74	BKF-4DM-16-G	22	BKF-8DM-6-G	21	BKF-AF-8-G	18
BKDWR-1820-ASSY-L-SS	86	BKF-4DM-18-G	22	BKF-8DM-8-G	21	BKF-BDMPF-G	26
BKDWR-1820-ASSY-PL	74	BKF-4DM-3G-G	22	BKF-8DM-8G-G	21	BKF-BDMPR-WB-G	16
BKDWR-1820-ASSY-SS	74	BKF-4DM-5G-G	22	BKF-8DMPF-G	26	BKF-BDMUS-G	25
BKDWR-2015	86	BKF-4DM-6-G	22	BKF-8DMUS-G	25	BKF-BSMPF-G	26
BKDWR-2015-ASSY-L-PL	74	BKF-4DM-8-G	22	BKF-8G-G	21	BKF-BSMUS-G	25
BKDWR-2015-ASSY-L-PL	86	BKF-4DM-8G-G	22	BKF-8HDDPR-WB-G	16	BKF-BWMPR-WB-G	16
BKDWR-2015-ASSY-L-SS	74	BKF-4DMPF-G	26	BKF-8HR-G	23	BKF-C414-VR	28
BKDWR-2015-ASSY-L-SS	86	BKF-4DMUS-G	25	BKF-8MFD-G	6	BKF-C414-VR	18
BKDWR-2015-ASSY-L-SS-SPR-24	74	BKF-4HDDPR-WB-G	16	BKF-8SM-10-G	21	BKF-CAS-9B-G	7
BKDWR-2015-ASSY-L-SS-SPR-30	74	BKF-4HR-G	23	BKF-8SM-12-G	21	BKF-CAS-9H-G	7
BKDWR-2015-ASSY-PL	74	BKF-4MFD-G	6	BKF-8SM-14-G	21	BKF-CAS-9T-G	7
BKDWR-2015-ASSY-PL	86	BKF-4SM-10-G	22	BKF-8SM-16-G	21	BKF-CDPR-WB-AF12-G	12
BKDWR-2015-ASSY-SS	74	BKF-4SM-12-G	22	BKF-8SM-18-G	21	BKF-CDPR-WB-G	12
BKDWR-2015-ASSY-SS	86	BKF-4SM-14-G	22	BKF-8SM-3G-G	21	BKF-CH	17
BKDWR-2015-ASSY-SS-SPR-24	74	BKF-4SM-16-G	22	BKF-8SM-5G-G	21	BKF-CSPR-WB-AF12-G	12
BKDWR-2015-ASSY-SS-SPR-30	74	BKF-4SM-18-G	22	BKF-8SM-6-G	21	BKF-CSPR-WB-G	12
BKDWR-2015-PL	86	BKF-4SM-3G-G	22	BKF-8SM-8-G	21	BKF-CV-G	17
BKDWR-2020	86	BKF-4SM-5G-G	22	BKF-8SM-8G-G	21	BKF-CV-H-G	17
BKDWR-2020-ASSY-L-PL	74	BKF-4SM-6-G	22	BKF-8SMPF-G	26	BKF-DBH	17

Part #	Page #	Part #	Page #	Part #	Page #	Part #	Page #
BKF-DDMPF-G	26	BKF-HV-H-G	17	BKF-SPF-8-G	23	BKF-W2-3G-G	20
BKF-DDMUS-G	25	BKF-IMDPR-WB	11	BKF-SPF-8G-G	23	BKF-W2-5G-G	20
BKF-DEF-3G	7	BKF-IMH	14	BKF-SPSF-G	18	BKF-W2-6-G	20
BKF-DHR-G	23	BKF-IMPVPRO	14	BKF-SPT-10-G	18	BKF-W2-8-G	20
BKF-DMB-10-G	24	BKF-IMSPR-WB	11	BKF-SPT-12-G	18	BKF-W2-8G-G	20
BKF-DMB-12-G	24	BKF-JET-9B-G	7	BKF-SPT-14-G	18	BKF-WBH	17
BKF-DMB-14-G	24	BKF-JET-9H-G	7	BKF-SPT-16-G	18	BKF-WMB-10-G	24
BKF-DMB-16-G	24	BKF-JET-9T-G	7	BKF-SPT-18-G	18	BKF-WMB-12-G	24
BKF-DMB-18-G	24	BKF-KAI-9B-G	7	BKF-SPT-3G-G	18	BKF-WMB-14-G	24
BKF-DMB-3G-G	24	BKF-KAI-9H-G	7	BKF-SPT-5G-G	18	BKF-WMB-16-G	24
BKF-DMB-5G-G	24	BKF-KAI-9T-G	7	BKF-SPT-6-G	18	BKF-WMB-18-G	24
BKF-DMB-6-G	24	BKF-KC3PRV	14	BKF-SPT-8-G	18	BKF-WMB-3G-G	24
BKF-DMB-8-G	24	BKF-LF-4HDDPR-WB-G	16	BKF-SPT-8G-G	18	BKF-WMB-5G-G	24
BKF-DMB-8G-G	24	BKF-LF-8HDDPR-WB-G	16	BKF-SSMPF-G	26	BKF-WMB-6-G	24
BKF-DMPR-WB-AF10-G	15	BKF-LF-BDMPR-WB-G	16	BKF-SSMUS-G	25	BKF-WMB-8-G	24
BKF-DMPR-WB-AF12-G	15	BKF-LF-BWMPR-WB-G	16	BKF-SVSPR-WB-AF12-G	13	BKF-WMB-8G-G	24
BKF-DMPR-WB-AF14-G	15	BKF-LF-DMPR-WB-G	15	BKF-SVSPR-WB-G	13	BKF-WPF-10-G	23
BKF-DMPR-WB-AF8-G	15	BKF-LF-SDMPR-WB-G	16	BKF-SWMPR-WB-G	16	BKF-WPF-12-G	23
BKF-DMPR-WB-G	15	BKF-LF-SMPR-WB-G	15	BKF-VSMPR-WB-AF10-G	15	BKF-WPF-14-G	23
BKF-DPF-10-G	23	BKF-LF-SWMPR-WB-G	16	BKF-VSMPR-WB-AF12-G	15	BKF-WPF-16-G	23
BKF-DPF-12-G	23	BKF-LF-VSMPR-WB-G	15	BKF-VSMPR-WB-AF14-G	15	BKF-WPF-18-G	23
BKF-DPF-14-G	23	BKF-SBH	17	BKF-VSMPR-WB-AF8-G	15	BKF-WPF-3G-G	23
BKF-DPF-16-G	23	BKF-SDMPF-G	26	BKF-VSMPR-WB-G	15	BKF-WPF-5G-G	23
BKF-DPF-18-G	23	BKF-SDMPR-WB-G	16	BKF-W-10-G	20	BKF-WPF-6-G	23
BKF-DPF-3G-G	23	BKF-SDMUS-G	25	BKF-W-12-G	20	BKF-WPF-8-G	23
BKF-DPF-5G-G	23	BKF-SEF-3G	7	BKF-W-14-G	20	BKF-WPF-8G-G	23
BKF-DPF-6-G	23	BKF-SGF-G	19	BKF-W-16-G	20	BKF4HD-10-G	22
BKF-DPF-8-G	23	BKF-SGF-G	40	BKF-W-18-G	20	BKF4HD-12-G	22
BKF-DPF-8G-G	23	BKF-SHR-G	23	BKF-W-3G-G	20	BKF4HD-14-G	22
BKF-DWF-G	19	BKF-SMPR-WB-AF10-G	15	BKF-W-5G-G	20	BKF4HD-16-G	22
BKF-ESC	18	BKF-SMPR-WB-AF12-G	15	BKF-W-6-G	20	BKF4HD-18-G	22
BKF-HSPT-10-G	18	BKF-SMPR-WB-AF14-G	15	BKF-W-8-G	20	BKF4HD-3G-G	22
BKF-HSPT-12-G	18	BKF-SMPR-WB-AF8-G	15	BKF-W-8G-G	20	BKF4HD-5G-G	22
BKF-HSPT-14-G	18	BKF-SMPR-WB-G	15	BKF-W-CV-G	17	BKF4HD-6-G	22
BKF-HSPT-16-G	18	BKF-SPF-10-G	23	BKF-W-CVC-G	17	BKF4HD-8-G	22
BKF-HSPT-18-G	18	BKF-SPF-12-G	23	BKF-W-HV-G	17	BKF4HD-8G-G	22
BKF-HSPT-3G-G	18	BKF-SPF-14-G	23	BKF-W-HVC-G	17	BKF8HD-10-G	22
BKF-HSPT-5G-G	18	BKF-SPF-16-G	23	BKF-W2-10-G	20	BKF8HD-12-G	22
BKF-HSPT-6-G	18	BKF-SPF-18-G	23	BKF-W2-12-G	20	BKF8HD-14-G	22
BKF-HSPT-8-G	18	BKF-SPF-3G-G	23	BKF-W2-14-G	20	BKF8HD-16-G	22
BKF-HSPT-8G-G	18	BKF-SPF-5G-G	23	BKF-W2-16-G	20	BKF8HD-18-G	22
BKF-HV-G	17	BKF-SPF-6-G	23	BKF-W2-18-G	20	BKF8HD-3G-G	22



Part #	Page #	Part #	Page #	Part #	Page #	Part #	Page #
BKF8HD-5G-G	22	BKG-GHC-10024	4	BKG-GHC-5036	4	BKG-GHC-7548	4
BKF8HD-6-G	22	BKG-GHC-10024-PT	3	BKG-GHC-5036-PT	3	BKG-GHC-7548-PT	3
BKF8HD-8-G	22	BKG-GHC-10024-QD-PT	3	BKG-GHC-5036-QD-PT	3	BKG-GHC-7548-QD-PT	3
BKF8HD-8G-G	22	BKG-GHC-10024-SCK2	2	BKG-GHC-5036-SCK2	2	BKG-GHC-7548-SCK2	2
BKFB-1115-11-16	91	BKG-GHC-10024-SCK3	2	BKG-GHC-5036-SCK3	2	BKG-GHC-7548-SCK3	2
BKFB-1410-8-14	91	BKG-GHC-10024-SCK9	2	BKG-GHC-5036-SCK9	2	BKG-GHC-7548-SCK9	2
BKFB-1431-12-16	91	BKG-GHC-10024-SW3	1	BKG-GHC-5036-SW3	1	BKG-GHC-7548-SW3	1
BKFB-1431-14-14	91	BKG-GHC-10036	4	BKG-GHC-5048	4	BKG-GHC-7560	4
BKFB-1616-10-16	91	BKG-GHC-10036-PT	3	BKG-GHC-5048-PT	3	BKG-GHC-7560-PT	3
BKFB-1618-12-16	91	BKG-GHC-10036-QD-PT	3	BKG-GHC-5048-QD-PT	3	BKG-GHC-7560-QD-PT	3
BKFB-1618-14-16	91	BKG-GHC-10036-SCK2	2	BKG-GHC-5048-SCK2	2	BKG-GHC-7560-SCK2	2
BKFB-1620-12-16	91	BKG-GHC-10036-SCK3	2	BKG-GHC-5048-SCK3	2	BKG-GHC-7560-SCK3	2
BKFB-1818-12-16	91	BKG-GHC-10036-SCK9	2	BKG-GHC-5048-SCK9	2	BKG-GHC-7560-SCK9	2
BKFB-1818-14-16	91	BKG-GHC-10036-SW3	1	BKG-GHC-5048-SW3	1	BKG-GHC-7560-SW3	1
BKFB-1824-12-16	91	BKG-GHC-10048	4	BKG-GHC-5060	4	BKG-GHC-7572	4
BKFB-1824-14-14	91	BKG-GHC-10048-PT	3	BKG-GHC-5060-PT	3	BKG-GHC-7572-PT	3
BKFB-1830-12-14	91	BKG-GHC-10048-QD-PT	3	BKG-GHC-5060-QD-PT	3	BKG-GHC-7572-QD-PT	3
BKFB-2020-12-14	91	BKG-GHC-10048-SCK2	2	BKG-GHC-5060-SCK2	2	BKG-GHC-7572-SCK2	2
BKFB-2020-12-16	91	BKG-GHC-10048-SCK3	2	BKG-GHC-5060-SCK3	2	BKG-GHC-7572-SCK3	2
BKFB-2020-8-16	91	BKG-GHC-10048-SCK9	2	BKG-GHC-5060-SCK9	2	BKG-GHC-7572-SCK9	2
BKFB-2028-12-14	91	BKG-GHC-10048-SW3	1	BKG-GHC-5060-SW3	1	BKG-GHC-7572-SW3	1
BKFB-2028-12-16	91	BKG-GHC-10060	4	BKG-GHC-5072	4	BKG-QDC-100	3
BKFB-2028-14-14	91	BKG-GHC-10060-PT	3	BKG-GHC-5072-PT	3	BKG-QDC-50	3
BKFB-2030-12-14	91	BKG-GHC-10060-QD-PT	3	BKG-GHC-5072-QD-PT	3	BKG-QDC-75	3
BKFB-2424-12-16	91	BKG-GHC-10060-SCK2	2	BKG-GHC-5072-SCK2	2	BKG-RCK-24	3
BKFB-2424-14-14	91	BKG-GHC-10060-SCK3	2	BKG-GHC-5072-SCK3	2	BKG-RCK-36	3
BKFB-2424-14-16	91	BKG-GHC-10060-SCK9	2	BKG-GHC-5072-SCK9	2	BKG-RCK-48	3
BKFB-2430-12-16	91	BKG-GHC-10060-SW3	1	BKG-GHC-5072-SW3	1	BKG-RCK-60	3
BKFB-3024-12-16	91	BKG-GHC-10072	4	BKG-GHC-7524	4	BKG-RCK-72	3
BKFB-3024-14-14	91	BKG-GHC-10072-PT	3	BKG-GHC-7524-PT	3	BKGF-1216-4SH	85
BKFV-DGS-G	24	BKG-GHC-10072-QD-PT	3	BKG-GHC-7524-QD-PT	3	BKGF-1220-4SH	85
BKFV-G	24	BKG-GHC-10072-SCK2	2	BKG-GHC-7524-SCK2	2	BKGF-2016-4SH	85
BKFVSGS-G	24	BKG-GHC-10072-SCK3	2	BKG-GHC-7524-SCK3	2	BKGF-2020-4SH	85
BKG-100SW	1	BKG-GHC-10072-SCK9	2	BKG-GHC-7524-SCK9	2	BKH-44-G	14
BKG-50SW	1	BKG-GHC-10072-SW3	1	BKG-GHC-7524-SW3	1	BKH-44-G	26
BKG-75SW	1	BKG-GHC-5024	4	BKG-GHC-7536	4	BKH-60-G	14
BKG-90E100	3	BKG-GHC-5024-PT	3	BKG-GHC-7536-PT	3	BKH-60-G	26
BKG-90E50	3	BKG-GHC-5024-QD-PT	3	BKG-GHC-7536-QD-PT	3	BKH-72-G	14
BKG-90E75	3	BKG-GHC-5024-SCK2	2	BKG-GHC-7536-SCK2	2	BKH-72-G	26
BKG-BV100	3	BKG-GHC-5024-SCK3	2	BKG-GHC-7536-SCK3	2	BKH-HANDLE	14
BKG-BV50	3	BKG-GHC-5024-SCK9	2	BKG-GHC-7536-SCK9	2	BKHS-ADA-D	38
BKG-BV75	3	BKG-GHC-5024-SW3	1	BKG-GHC-7536-SW3	1	BKHS-ADA-D-P-G	38

Part #	Page #	Part #	Page #	Part #	Page #	Part #	Page #
BKHS-ADA-S	38	BKHS-W-1410-P-G	36	BKIB-CP8-3012-21S	53	BKMWS-1824	58
BKHS-ADA-S-P-G	38	BKHS-W-1410-PED	38	BKIB-CP8-3612-18S	55	BKMWS-2024	58
BKHS-D-1410	36	BKHS-W-1410-PED-P-G	38	BKIB-CP8-3612-21S	53	BKMWS-2030	58
BKHS-D-1410-1	36	BKHS-W-1410-RS	36	BKIB-CP8-4812-18S	55	BKMWS-2424	58
BKHS-D-1410-1-BKK	37	BKHS-W-1410-RS-P-G	36	BKIB-CP8-4812-21S	53	BKPT-3060G-L	73
BKHS-D-1410-1-BKK-P-G	37	BKHS-W-1410-SS	36	BKIB-L-2418	55	BKPT-3060G-L-P-G	73
BKHS-D-1410-1-SS-BKK	37	BKHS-W-1410-SS-P-G	36	BKIB-L-2421	53	BKPT-3060G-R	73
BKHS-D-1410-1-SS-BKK-P-G	37	BKHS-W-1620	38	BKIB-L-3018	55	BKPT-3060G-R-P-G	73
BKHS-D-1410-P-G	36	BKHS-W-1620-1	38	BKIB-L-3021	53	BKPT-3060S-L	73
BKHS-D-1410-SKTS	37	BKHS-W-1620-1-SS	38	BKIB-L-3618	55	BKPT-3060S-L-P-G	73
BKHS-D-1410-SKTS-P-G	37	BKHS-W-1620-P-G	38	BKIB-L-3621	53	BKPT-3060S-R	73
BKHS-D-1410-SS	36	BKHS-W-SS	37	BKIB-L-4818	55	BKPT-3060S-R-P-G	73
BKHS-D-1410-SS-P-G	36	BKHS-W-SS-1	37	BKIB-L-4821	53	BKPT-3072G-L	73
BKHS-D-1616	38	BKHS-W-SS-1-SS	37	BKKV-010XST	17	BKPT-3072G-L-P-G	73
BKHS-D-1616-SS	38	BKHS-W-SS-P-G	37	BKKV-DGS-G	24	BKPT-3072G-R	73
BKHS-D-SS	37	BKHS-W-SS-SS	37	BKKV-G	24	BKPT-3072G-R-P-G	73
BKHS-D-SS-P-G	37	BKHS-W-SS-SS-P-G	37	BKKVSGS-G	24	BKPT-3072S-L	73
BKHS-D-SS-SKTS	37	BKHS-W-SS-SS-TD	37	BKL-1625-WP	88	BKPT-3072S-L-P-G	73
BKHS-D-SS-SKTS-P-G	37	BKHS-W-SS-SS-TD-P-G	37	BKL-20-WP	88	BKPT-3072S-R	73
BKHS-D-SS-SS	37	BKIB-2412-18S	55	BKL-24SS	88	BKPT-3072S-R-P-G	73
BKHS-D-SS-SS-P-G	37	BKIB-2412-21-KITS	53	BKL-36SS	88	BKS-1-1620-12	31
BKHS-DWSS	37	BKIB-2412-21S	53	BKL-4-BP	88	BKS-1-1620-12-18L	31
BKHS-DWSS	35	BKIB-3012-18S	55	BKL-4-NPE	88	BKS-1-1620-12-18R	31
BKHS-SSD1410	35	BKIB-3012-21-KITS	53	BKL-4-NPE-H	88	BKS-1-1620-12-18T	31
BKHS-SSW1410	35	BKIB-3012-21S	53	BKL-4-NPE-N	88	BKS-1-18-12	31
BKHS-SWSS	35	BKIB-3612-18S	55	BKL-6SS	88	BKS-1-18-12-18L	31
BKHS-SWSS	37	BKIB-3612-21-KITS	53	BKL-DT-SS	42	BKS-1-18-12-18R	31
BKHS-W-1410	36	BKIB-3612-21S	53	BKL-DT-SS	43	BKS-1-18-12-18T	31
BKHS-W-1410-1	36	BKIB-4812-18S	55	BKL-SSH-1014	30	BKS-1-1824-14	31
BKHS-W-1410-1-4D	36	BKIB-4812-21-KITS	53	BKL-SSH-1216	30	BKS-1-1824-14-24L	31
BKHS-W-1410-1-4D-TD	36	BKIB-4812-21S	53	BKL-SSH-1218	30	BKS-1-1824-14-24R	31
BKHS-W-1410-1-BKK	37	BKIB-CP7-2412-18S	55	BKL-SSH-1220	30	BKS-1-1824-14-24T	31
BKHS-W-1410-1-BKK-P-G	37	BKIB-CP7-2412-21S	53	BKL-SSH-1230	30	BKS-1-20-12	31
BKHS-W-1410-1-SS	36	BKIB-CP7-3012-18S	55	BKL-SSH-1415	30	BKS-1-24-14	31
BKHS-W-1410-1-SS-BKK	37	BKIB-CP7-3012-21S	53	BKL-SSH-1418	30	BKS-1-24-14-24L	31
BKHS-W-1410-1-SS-BKK-P-G	37	BKIB-CP7-3612-18S	55	BKL-SSH-1420	30	BKS-1-24-14-24R	31
BKHS-W-1410-4D	36	BKIB-CP7-3612-21S	53	BKL-SSH-1424	30	BKS-1-24-14-24T	31
BKHS-W-1410-4D-P-G	36	BKIB-CP7-4812-18S	55	BKL-SSH-1430	30	BKS-1-SK-20-8-ME	34
BKHS-W-1410-4D-TD	36	BKIB-CP7-4812-21S	53	BKMS-1620-12	34	BKS-2-1620-12	30
BKHS-W-1410-4D-TD-P-G	36	BKIB-CP8-2412-18S	55	BKMS-1620-12-KIT	34	BKS-2-1620-12-18L	30
BKHS-W-1410-LS	36	BKIB-CP8-2412-21S	53	BKMS-1620-6	34	BKS-2-1620-12-18R	30
BKHS-W-1410-LS-P-G	36	BKIB-CP8-3012-18S	55	BKMS-1620-6-KIT	34	BKS-2-1620-12-18T	30

Part #	Page #	Part #	Page #	Part #	Page #	Part #	Page #
BKS-2-18-12	30	BKS-3-24-14-24T	29	BKSDT-48-L-P2-G	42	BKSDT-72-R-SS	42
BKS-2-18-12-18L	30	BKS-4-1620-14-18T	32	BKSDT-48-L-P3-G	42	BKSDT-72-R-SS-P-G	42
BKS-2-18-12-18R	30	BKS-RES-18	35	BKSDT-48-L-SS	42	BKSDT-72-R-SS-P2-G	42
BKS-2-18-12-18T	30	BKS-RES-20	35	BKSDT-48-L-SS-P-G	42	BKSDT-72-R-SS-P3-G	42
BKS-2-20-12-18T	30	BKS-RES-24	35	BKSDT-48-L-SS-P2-G	42	BKSF-9V	8
BKS-2-24-14	30	BKSDRWPL	87	BKSDT-48-L-SS-P3-G	42	BKSF-WB1	19
BKS-2-24-14-24L	30	BKSDT-26-L	42	BKSDT-48-R	42	BKSF-WB1	34
BKS-2-24-14-24R	30	BKSDT-26-L-P-G	42	BKSDT-48-R-P-G	42	BKSF-WB2	34
BKS-2-24-14-24T	30	BKSDT-26-L-P2-G	42	BKSDT-48-R-P2-G	42	BKSPFV-DGS-G	24
BKS-3-1014-10	32	BKSDT-26-L-P3-G	42	BKSDT-48-R-P3-G	42	BKSPFV-G	24
BKS-3-1014-10-15L	32	BKSDT-26-L-SS	42	BKSDT-48-R-SS	42	BKSPFV-SGS-G	24
BKS-3-1014-10-15R	32	BKSDT-26-L-SS-P-G	42	BKSDT-48-R-SS-P-G	42	BKSPKV-DGS-G	24
BKS-3-1014-10-15T	32	BKSDT-26-L-SS-P2-G	42	BKSDT-48-R-SS-P2-G	42	BKSPKV-G	24
BKS-3-1220-12-12T	32	BKSDT-26-L-SS-P3-G	42	BKSDT-48-R-SS-P3-G	42	BKSPKVSGS-G	24
BKS-3-1416-12-12T	32	BKSDT-26-R	42	BKSDT-60-L	42	BKSSDPH	65
BKS-3-15-14	29	BKSDT-26-R-P-G	42	BKSDT-60-L-P-G	42	BKSSDPH	92
BKS-3-15-14-15L	29	BKSDT-26-R-P2-G	42	BKSDT-60-L-P2-G	42	BKSSPH	65
BKS-3-15-14-15R	29	BKSDT-26-R-P3-G	42	BKSDT-60-L-P3-G	42	BKSSPH	92
BKS-3-15-14-15T	29	BKSDT-26-R-SS	42	BKSDT-60-L-SS	42	BKSSRPD	87
BKS-3-1620-12	29	BKSDT-26-R-SS-P-G	42	BKSDT-60-L-SS-P-G	42	BKUB-LD12-18S	55
BKS-3-1620-12-18L	29	BKSDT-26-R-SS-P2-G	42	BKSDT-60-L-SS-P2-G	42	BKUB-LD12-21S	53
BKS-3-1620-12-18R	29	BKSDT-26-R-SS-P3-G	42	BKSDT-60-L-SS-P3-G	42	BKUB-LD18-18S	55
BKS-3-1620-12-18T	29	BKSDT-3-20-12-20LS	41	BKSDT-60-R	42	BKUB-LD18-21S	53
BKS-3-1620-14-18T	29	BKSDT-3-20-12-20RS	41	BKSDT-60-R-P-G	42	BKUB-LD24-18S	55
BKS-3-18-12	29	BKSDT-36-L	42	BKSDT-60-R-P2-G	42	BKUB-LD24-21S	53
BKS-3-18-12-18L	29	BKSDT-36-L-P-G	42	BKSDT-60-R-P3-G	42	BKUB-LD36-18S	55
BKS-3-18-12-18R	29	BKSDT-36-L-P2-G	42	BKSDT-60-R-SS	42	BKUB-LD36-21S	53
BKS-3-18-12-18T	29	BKSDT-36-L-P3-G	42	BKSDT-60-R-SS-P-G	42	BKUB-SS18	35
BKS-3-18-12-24T	29	BKSDT-36-L-SS	42	BKSDT-60-R-SS-P2-G	42	BKUB-SS18	56
BKS-3-18-14-18T	29	BKSDT-36-L-SS-P-G	42	BKSDT-60-R-SS-P3-G	42	BKUB-SS21	35
BKS-3-1824-14-18T	29	BKSDT-36-L-SS-P2-G	42	BKSDT-72-L	42	BKUB-SS21	54
BKS-3-1824-14-24L	29	BKSDT-36-L-SS-P3-G	42	BKSDT-72-L-P-G	42	BKUB-WS-114-GS	52
BKS-3-1824-14-24R	29	BKSDT-36-R	42	BKSDT-72-L-P2-G	42	BKUB-WS-54-GS	52
BKS-3-1824-14-24T	29	BKSDT-36-R-P-G	42	BKSDT-72-L-P3-G	42	BKUB-WS-60-GS	52
BKS-3-1824-14-24TL	32	BKSDT-36-R-P2-G	42	BKSDT-72-L-SS	42	BKUB-WS-66-GS	52
BKS-3-20-12-18T	29	BKSDT-36-R-P3-G	42	BKSDT-72-L-SS-P-G	42	BKUB-WS-78-GS	52
BKS-3-20-14-24T	29	BKSDT-36-R-SS	42	BKSDT-72-L-SS-P2-G	42	BKUB-WS-90-GS	52
BKS-3-2030-12-20T	29	BKSDT-36-R-SS-P-G	42	BKSDT-72-L-SS-P3-G	42	BKUB-WS-BSIB-42-GS	52
BKS-3-2030-14-24T	29	BKSDT-36-R-SS-P2-G	42	BKSDT-72-R	42	BKUB-WS-BSIB-48-GS	52
BKS-3-24-14	29	BKSDT-36-R-SS-P3-G	42	BKSDT-72-R-P-G	42	BKUB-WS-BSIB-54-GS	52
BKS-3-24-14-24L	29	BKSDT-48-L	42	BKSDT-72-R-P2-G	42	BKUB-WS-BSIB-66-GS	52
BKS-3-24-14-24R	29	BKSDT-48-L-P-G	42	BKSDT-72-R-P3-G	42	BKUB-WS-IBDB-48S	52

Part #	Page #	Part #	Page #	Part #	Page #	Part #	Page #
BKUB-WS-IBDB-60S	52	BKUBS-236LS	54	BKUBW-472TS	56	BKWS-1272-PR	59
BKUB-WS-IBDB-72S	52	BKUBS-236RS	54	BKUBW-484TS	56	BKWS-1284	59
BKUB-WS-IBDB-96S	52	BKUBS-248LS	54	BKUBW-496TS	56	BKWS-1284-PR	59
BKUBD-12-18S	56	BKUBS-248RS	54	BKUCDT-50-L	45	BKWS-1296	59
BKUBD-12-21S	54	BKUBS-248TS	54	BKUCDT-50-L-P-G	45	BKWS-1296-PR	59
BKUBD-18-18S	56	BKUBS-336S	54	BKUCDT-50-L-P3-G	45	BKWS-1624	59
BKUBD-18-21S	54	BKUBS-348LS	54	BKUCDT-50-L-SS	45	BKWS-1624-PR	59
BKUBD-24-18S	56	BKUBS-348RS	54	BKUCDT-50-L-SS-P-G	45	BKWS-1630	59
BKUBD-24-21S	54	BKUBS-360LS	54	BKUCDT-50-L-SS-P3-G	45	BKWS-1630-PR	59
BKUBD-30-18S	56	BKUBS-360RS	54	BKUCDT-50-R	45	BKWS-1636	59
BKUBD-30-21S	54	BKUBS-360TS	54	BKUCDT-50-R-P-G	45	BKWS-1636-PR	59
BKUBD-36-18S	56	BKUBS-372TS	54	BKUCDT-50-R-P3-G	45	BKWS-1648	59
BKUBD-36-21S	54	BKUBS-384TS	54	BKUCDT-50-R-SS	45	BKWS-1648-PR	59
BKUBD-48-18S	56	BKUBS-396TS	54	BKUCDT-50-R-SS-P-G	45	BKWS-1660	59
BKUBD-48-21S	54	BKUBS-448S	54	BKUCDT-50-R-SS-P3-G	45	BKWS-1660-PR	59
BKUBD-C1818S	56	BKUBS-472TS	54	BKUCDT-60-L	45	BKWS-1672	59
BKUBD-C2121S	54	BKUBS-484TS	54	BKUCDT-60-L-P-G	45	BKWS-1672-PR	59
BKUBDMX-12-18S	57	BKUBS-496TS	54	BKUCDT-60-L-P3-G	45	BKWS-1684	59
BKUBDMX-12-21S	57	BKUBSR-2-24	57	BKUCDT-60-L-SS	45	BKWS-1684-PR	59
BKUBDMX-18-18S	57	BKUBSR-2-30	57	BKUCDT-60-L-SS-P-G	45	BKWS-1696	59
BKUBDMX-18-21S	57	BKUBSR-2-36	57	BKUCDT-60-L-SS-P3-G	45	BKWS-1696-PR	59
BKUBGC-241	57	BKUBSR-2-48	57	BKUCDT-60-R	45	BKWSE-1224	60
BKUBGC-242	57	BKUBSR-24	57	BKUCDT-60-R-P-G	45	BKWSE-1224-PR	60
BKUBS-1012HST-218S-P-G	56	BKUBSR-30	57	BKUCDT-60-R-P3-G	45	BKWSE-1232	60
BKUBS-1012HST-218S	56	BKUBSR-36	57	BKUCDT-60-R-SS	45	BKWSE-1236	60
BKUBS-1012HST-221S-P-G	54	BKUBSR-48	57	BKUCDT-60-R-SS-P-G	45	BKWSE-1236-PR	60
BKUBS-1012HST-221S	54	BKUBW-224S	56	BKUCDT-60-R-SS-P3-G	45	BKWSE-1248	60
BKUBS-1012HST-518S-P-G	56	BKUBW-236LS	56	BKWCH-1524	62	BKWSE-1248-PR	60
BKUBS-1012HST-518S	56	BKUBW-236RS	56	BKWCH-1530	62	BKWSE-1260	60
BKUBS-1012HST-521S-P-G	54	BKUBW-248LS	56	BKWCH-1536	62	BKWSE-1260-PR	60
BKUBS-1012HST-521S	54	BKUBW-248RS	56	BKWCH-1548	62	BKWSE-1272	60
BKUBS-1014HS12-18S	56	BKUBW-248TS	56	BKWS-1224	59	BKWSE-1272-PR	60
BKUBS-1014HS12-18S-P-G	56	BKUBW-336S	56	BKWS-1224-PR	59	BKWSE-1284	60
BKUBS-1014HS-18-P-GS	56	BKUBW-348LS	56	BKWS-1230	59	BKWSE-1284-PR	60
BKUBS-1014HS-18S	56	BKUBW-348RS	56	BKWS-1230-PR	59	BKWSE-1296	60
BKUBS-1014HS-P-GS	54	BKUBW-360LS	56	BKWS-1236	59	BKWSE-1296-PR	60
BKUBS-1014HSS	54	BKUBW-360RS	56	BKWS-1236-PR	59	BKWSE-1624	60
BKUBS-1014HS12S	54	BKUBW-360TS	56	BKWS-1248	59	BKWSE-1624-PR	60
BKUBS-1014HS12S-P-G	54	BKUBW-372TS	56	BKWS-1248-PR	59	BKWSE-1632	60
BKUBS-1410BS-P-GS	53	BKUBW-384TS	56	BKWS-1260	59	BKWSE-1636	60
BKUBS-1410BSS	53	BKUBW-396TS	56	BKWS-1260-PR	59	BKWSE-1636-PR	60
BKUBS-224S	54	BKUBW-448S	56	BKWS-1272	59	BKWSE-1648	60

Part #	Page #	Part #	Page #	Part #	Page #	Part #	Page #
BKWSE-1648-PR	60	SVET-2430	75	SVTOB-4824	70	SVTR5-7224	68
BKWSE-1660	60	SVET-3630	75	SVTOB-4830	70	SVTR5-7230	68
BKWSE-1660-PR	60	SVET-4830	75	SVTOB-6024	70	SVTR5-9624	68
BKWSE-1672	60	SVET-6030	75	SVTOB-6030	70	SVTR5-9630	68
BKWSE-1672-PR	60	SVET-7230	75	SVTOB-7224	70	SVTR5OB-2424	70
BKWSE-1684	60	SVET-7230-6	75	SVTOB-7230	70	SVTR5OB-3024	70
BKWSE-1684-PR	60	SVT-1824	68	SVTOB-8424	70	SVTR5OB-3030	70
BKWSE-1696	60	SVT-1830	68	SVTOB-8430	70	SVTR5OB-3624	70
BKWSE-1696-PR	60	SVT-1836	68	SVTOB-9624	70	SVTR5OB-3630	70
DBC-11-24	51	SVT-1848	68	SVTOB-9630	70	SVTR5OB-4824	70
DBC-22-59	51	SVT-1860	68	SVTR-1824	68	SVTR5OB-4830	70
DBC-22-69	51	SVT-1872	68	SVTR-1830	68	SVTR5OB-6024	70
DBC-24-95	51	SVT-1884	68	SVTR-1836	68	SVTR5OB-6030	70
LDR-SS-35	27	SVT-1896	68	SVTR-1848	68	SVTR5OB-7224	70
MST-2424GS	75	SVT-2424	68	SVTR-1860	68	SVTR5OB-7230	70
MST-2424SS	75	SVT-3024	68	SVTR-1872	68	SVTR5OB-8424	70
MST-3024GS	75	SVT-3030	68	SVTR-1884	68	SVTR5OB-8430	70
MST-3024SS	75	SVT-3624	68	SVTR-1896	68	SVTR5OB-9624	70
MST-3030GS	75	SVT-3630	68	SVTR-2424	68	SVTR5OB-9630	70
MST-3030SS	75	SVT-4824	68	SVTR-3024	68	SVTROB-1824	70
MST-3630GS	75	SVT-4830	68	SVTR-3030	68	SVTROB-1830	70
MST-3630SS	75	SVT-6024	68	SVTR-3624	68	SVTROB-1836	70
SB-16-2020-5	91	SVT-6030	68	SVTR-3630	68	SVTROB-1848	70
SFTS-1524	72	SVT-7224	68	SVTR-4824	68	SVTROB-1860	70
SFTS-1530	72	SVT-7230	68	SVTR-4830	68	SVTROB-1872	70
SFTS-1824	72	SVT-8424	68	SVTR-6024	68	SVTROB-1884	70
SFTS-1830	72	SVT-8430	68	SVTR-6030	68	SVTROB-1896	70
SFTS-2430	72	SVT-9624	68	SVTR-7224	68	SVTROB-2424	70
SSU3-3124	64	SVT-9630	68	SVTR-7230	68	SVTROB-3024	70
SSU3-4324	64	SVTOB-1824	70	SVTR-8424	68	SVTROB-3030	70
SSU3-5524	64	SVTOB-1830	70	SVTR-8430	68	SVTROB-3624	70
SSU3-6724	64	SVTOB-1836	70	SVTR-9624	68	SVTROB-3630	70
SSU5-3124	64	SVTOB-1848	70	SVTR-9630	68	SVTROB-4824	70
SSU5-4324	64	SVTOB-1860	70	SVTR5-2424	68	SVTROB-4830	70
SSU5-5524	64	SVTOB-1872	70	SVTR5-3024	68	SVTROB-6024	70
SSU5-6724	64	SVTOB-1884	70	SVTR5-3030	68	SVTROB-6030	70
SSU6-3124	64	SVTOB-1896	70	SVTR5-3624	68	SVTROB-7224	70
SSU6-4324	64	SVTOB-2424	70	SVTR5-3630	68	SVTROB-7230	70
SSU6-5524	64	SVTOB-3024	70	SVTR5-4824	68	SVTROB-8424	70
SSU6-6724	64	SVTOB-3030	70	SVTR5-4830	68	SVTROB-8430	70
SVET-1530	75	SVTOB-3624	70	SVTR5-6024	68	SVTROB-9624	70
SVET-1830	75	SVTOB-3630	70	SVTR5-6030	68	SVTROB-9630	70

Part #	Page #	Part #	Page #	Part #	Page #	Part #	Page #
SVTS-1824	68	VSU6-4324	64	VTT-6030	67	VTTR-3624	67
SVTS-1830	68	VSU6-5524	64	VTT-7224	67	VTTR-3630	67
SVTS-1836	68	VSU6-6724	64	VTT-7230	67	VTTR-4824	67
SVTS-1848	68	VTS-1824	67	VTT-8424	67	VTTR-4830	67
SVTS-1860	68	VTS-1830	67	VTT-8430	67	VTTR-6024	67
SVTS-1872	68	VTS-1836	67	VTT-9624	67	VTTR-6030	67
SVTS-1896	68	VTS-1848	67	VTT-9630	67	VTTR-7224	67
SVTS-2424	68	VTS-1860	67	VTT0B-1824	69	VTTR-7230	67
SVTS-3024	68	VTS-1872	67	VTT0B-1830	69	VTTR-8424	67
SVTS-3030	68	VTS-1884	67	VTT0B-1836	69	VTTR-8430	67
SVTS-3624	68	VTS-1896	67	VTT0B-1848	69	VTTR-9624	67
SVTS-3630	68	VTS-2424	67	VTT0B-1860	69	VTTR-9630	67
SVTS-4824	68	VTS-3024	67	VTT0B-1872	69	VTTR5-2424	67
SVTS-4830	68	VTS-3030	67	VTT0B-1884	69	VTTR5-3024	67
SVTS-6024	68	VTS-3624	67	VTT0B-1896	69	VTTR5-3030	67
SVTS-6030	68	VTS-3630	67	VTT0B-2424	69	VTTR5-3624	67
SVTS-7224	68	VTS-4824	67	VTT0B-3024	69	VTTR5-3630	67
SVTS-7230	68	VTS-4830	67	VTT0B-3030	69	VTTR5-4824	67
SVTS-9624	68	VTS-6024	67	VTT0B-3624	69	VTTR5-4830	67
SVTS-9630	68	VTS-6030	67	VTT0B-3630	69	VTTR5-6024	67
VETS-1530	75	VTS-7224	67	VTT0B-4824	69	VTTR5-6030	67
VETS-1830	75	VTS-7230	67	VTT0B-4830	69	VTTR5-7224	67
VETS-2430	75	VTS-8424	67	VTT0B-6024	69	VTTR5-7230	67
VETS-3630	75	VTS-8430	67	VTT0B-6030	69	VTTR5-8424	67
VETS-4830	75	VTS-9624	67	VTT0B-7224	69	VTTR5-8430	67
VETS-6030	75	VTS-9630	67	VTT0B-7230	69	VTTR5-9624	67
VETS-7230	75	VTT-1824	67	VTT0B-8424	69	VTTR5-9630	67
VETS-7230-6	75	VTT-1830	67	VTT0B-8430	69	VTTR50B-2424	69
VFTS-1524	72	VTT-1836	67	VTT0B-9624	69	VTTR50B-3024	69
VFTS-1530	72	VTT-1848	67	VTT0B-9630	69	VTTR50B-3030	69
VFTS-1824	72	VTT-1860	67	VTT0B-9636	69	VTTR50B-3624	69
VFTS-1830	72	VTT-1872	67	VTTR-1824	67	VTTR50B-3630	69
VFTS-2430	72	VTT-1884	67	VTTR-1830	67	VTTR50B-4824	69
VSU3-3124	64	VTT-1896	67	VTTR-1836	67	VTTR50B-4830	69
VSU3-4324	64	VTT-2424	67	VTTR-1848	67	VTTR50B-6024	69
VSU3-5524	64	VTT-3024	67	VTTR-1860	67	VTTR50B-6030	69
VSU3-6724	64	VTT-3030	67	VTTR-1872	67	VTTR50B-7224	69
VSU5-3124	64	VTT-3624	67	VTTR-1884	67	VTTR50B-7230	69
VSU5-4324	64	VTT-3630	67	VTTR-1896	67	VTTR50B-8424	69
VSU5-5524	64	VTT-4824	67	VTTR-2424	67	VTTR50B-8430	69
VSU5-6724	64	VTT-4830	67	VTTR-3024	67	VTTR50B-9624	69
VSU6-3124	64	VTT-6024	67	VTTR-3030	67	VTTR50B-9630	69

Part #	Page #	Part #	Page #	Part #	Page #	Part #	Page #
VTTROB-1824	69	VTTROB-6030	69	WSTR-9630	71	WTTR5-3630	71
VTTROB-1830	69	VTTROB-7224	69	WSTR5-3630	71	WTTR5-4830	71
VTTROB-1836	69	VTTROB-7230	69	WSTR5-4830	71	WTTR5-6030	71
VTTROB-1848	69	VTTROB-8424	69	WSTR5-6030	71	WTTR5-7230	71
VTTROB-1860	69	VTTROB-8430	69	WSTR5-7230	71	WTTR5-9630	71
VTTROB-1872	69	VTTROB-9624	69	WSTR5-9630	71	XRK-BKF-G	17
VTTROB-1884	69	VTTROB-9630	69	WTT-3630	71	XRK-LDR	18
VTTROB-1896	69	WST-3630	71	WTT-4830	71	XRK-LDR	27
VTTROB-2424	69	WST-4830	71	WTT-6030	71	XRK-PDV-G	17
VTTROB-3024	69	WST-6030	71	WTT-7230	71	XRK-PRV-G	14
VTTROB-3030	69	WST-7230	71	WTT-9630	71		
VTTROB-3624	69	WST-9630	71	WTTR-3630	71		
VTTROB-3630	69	WSTR-3630	71	WTTR-4830	71		
VTTROB-4824	69	WSTR-4830	71	WTTR-6030	71		
VTTROB-4830	69	WSTR-6030	71	WTTR-7230	71		
VTTROB-6024	69	WSTR-7230	71	WTTR-9630	71		

## Terms & Conditions

### F.O.B Factory

All BK Resources products are shipped F.O.B. Altamont, IL. - Flyer subject to change without notice.

### Ordering / Confirmations

We acknowledge all orders in writing and this acknowledgement constitutes our agreement with you regarding what is on your order. Please review your acknowledgement and fax back a signed copy of the acknowledgement to confirm your order is correct. We will NOT be held responsible for errors due to misunderstandings on orders.

### Drop Shipping

BK Resources will drop ship to any location, including residential addresses. Freight charges may be prepaid and added to your invoice if specified on shipments for locations other than the billing address. A \$5.00 drop ship fee will be charged for any orders being delivered to locations other than the billing address. **NOTE:** Lift gate service, notification of delivery, inside delivery and other special requirements will be subject to additional charges.

### Minimum Order Policy

\$50 NET minimum order. All orders under \$50 subject to \$25 handling fee or the difference between order total and \$50. Fee not to exceed \$25.

### Return Shipments

BK Resources will not accept any returned merchandise unless authorization has been issued. All returned goods due to customer error are subject to a 15% restocking fee and must be in the original box, new and unused condition. If we find the product is not new, a credit will not be issued and the customer will be asked if they want the product returned to them at their expense. No Returns after 90 Days.

Merchandise initially returned as defective, whose defect cannot be verified, will incur a 15% restocking fee as well as a freight charge for the replacement shipment and the freight charge for picking up the return.

### Freight Claims

BEFORE accepting any shipment, examine it carefully and note any damage or shortage on the Freight Bill **BEFORE** signing for delivery. Report any damage, shortage or concealed damage to BK Resources within 48 hours of delivery. Retain the original package for claim purposes. **BK Resources is not liable for any damage or loss that is not noted or reported prior to accepting delivery. BK Resources is also not responsible for the filing of freight claims associated with, nor liable for, any damaged merchandise that was shipped per customer instructions via Third Party or Collect.**

### U.P.S. Shipments

Any item not intended to ship U.P.S. and is indicated in the BK Resources catalog as shipping **Truck Line Only**; that the customer chooses to ship UPS, BK Resources will NOT file the freight claim on behalf of the customer.

### Free Freight Program:

**BK Resources Offers Free freight for \$2,000.00 + Net Invoiced Orders. We reserve the right to choose the shipper. Items must be in stock at the time of purchase. No free freight on back orders is allowed.**

**NOTE:** Lift gate service, notification of delivery, inside delivery and other special requirements will be subject to additional charges that will be invoiced to the customer once BK Resources has been notified of the additional charges from the shipping company.

Assembled Ladderback Chairs do not qualify for FREE FREIGHT.

### Warranty:

All BK Resources products come with a Standard 1 Year Manufacturer's Warranty against defects unless otherwise noted.



BK Resources' 75,000 sq. ft. Headquarters, Warehouse & Distribution Center, Altamont, IL



Part #	Page #	Part #	Page #	Part #	Page #	Part #	Page #
VTTROB-1824	69	VTTROB-6030	69	WSTR-9630	71	WTTR5-3630	71
VTTROB-1830	69	VTTROB-7224	69	WSTR5-3630	71	WTTR5-4830	71
VTTROB-1836	69	VTTROB-7230	69	WSTR5-4830	71	WTTR5-6030	71
VTTROB-1848	69	VTTROB-8424	69	WSTR5-6030	71	WTTR5-7230	71
VTTROB-1860	69	VTTROB-8430	69	WSTR5-7230	71	WTTR5-9630	71
VTTROB-1872	69	VTTROB-9624	69	WSTR5-9630	71	XRK-BKF-G	17
VTTROB-1884	69	VTTROB-9630	69	WTT-3630	71	XRK-LDR	18
VTTROB-1896	69	WST-3630	71	WTT-4830	71	XRK-LDR	27
VTTROB-2424	69	WST-4830	71	WTT-6030	71	XRK-PDV-G	17
VTTROB-3024	69	WST-6030	71	WTT-7230	71	XRK-PRV-G	14
VTTROB-3030	69	WST-7230	71	WTT-9630	71		
VTTROB-3624	69	WST-9630	71	WTTR-3630	71		
VTTROB-3630	69	WSTR-3630	71	WTTR-4830	71		
VTTROB-4824	69	WSTR-4830	71	WTTR-6030	71		
VTTROB-4830	69	WSTR-6030	71	WTTR-7230	71		
VTTROB-6024	69	WSTR-7230	71	WTTR-9630	71		

[www.dixieplumbingspecialites.com](http://www.dixieplumbingspecialites.com)

## COMMERICAL KITCHEN: GAS HOSES, FAUCETS, GREASE TRAPS & SINKS

- Handles
- Stems
- O.E.M. Parts
- Washers
- Gaskets
- Faucet Seats

- Spouts
- Trim
- Stoppers
- Flushometers
- Flex Supplies
- Tubular Brass

- Faucets
- Aerators
- Toilet Parts
- Ball Valves
- Gate Valves
- Brass Fittings

- Hangers
- Augers
- Drain Chemicals
- Hand Tools
- Thermocouples
- Drains

- Stem Lube
- Relief Valves
- Closet Seats
- Parts
- Commercial Parts
- Industrial Parts

## Looking for Plumbing Parts?

Call us at 1-800-327-8531

Email: [info@dixieplumbingspecialties.com](mailto:info@dixieplumbingspecialties.com)

WE SHIP  
WITHIN  
24 HOURS

OVER  
25,000  
ITEMS  
IN STOCK



"State of the Art Plumbing Parts"  
Factory Direct Distributors

**Dixie Plumbing Specialties, Inc.**  
PO Box 7237 Marietta, GA 30065  
Telephone 770-973-8017  
Toll Free USA 1-800-327-8531  
Toll Free Fax 1-800-882-7484

Thousands of Top Quality  
Plumbing Parts as close  
as your Telephone!

Dial Direct – No Charge!



DIXIE PLUMBING SPECIALTIES, INC.





# RESOURCES

## SOLID QUALITY. SOLID SERVICE.

**BK** RESOURCES  
Altamont, IL  
SOLID QUALITY. SOLID SERVICE.

*dps* Dixie Plumbing Specialties, Inc.

www.bk-resources.com

SP NSF IAPMO AODD G

f AQ

### Plumbing Display Stand



BK-36-PWDR

### Gas Hose Kit Display Stand



BK-GHR-36

### Gas Hose Display Stand

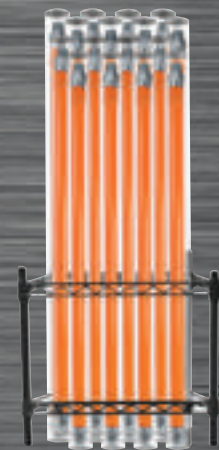

BK-GHMR